



mitsubishi
PROGRAMMABLE CONTROLLERS
MELSEC-F

Changes for the Better

OPERATION MANUAL

FX Configurator-EN

FX

FX Configurator-EN

Operation Manual

Manual number	JY997D20501
Manual revision	B
Date	3/2008

Foreword

This manual describes FX Configurator-EN and should be read and understood before attempting installation or operation of software.

Store this manual in a safe place so that you can take it out and read it whenever necessary. Always forward it to the end user.

This manual confers no industrial property rights or any rights of any other kind, nor does it confer any patent licenses. Mitsubishi Electric Corporation cannot be held responsible for any problems involving industrial property rights which may occur as a result of using the contents noted in this manual.

© 2005 MITSUBISHI ELECTRIC CORPORATION

Outline Precautions

- This manual provides information for the use of the FX Configurator-EN. The manual has been written to be used by trained and competent personnel. The definition of such a person or persons is as follows;
 - 1) Any engineer who is responsible for the planning, design and construction of automatic equipment using the product associated with this manual should be of a competent nature, trained and qualified to the local and national standards required to fulfill that role. These engineers should be fully aware of all aspects of safety with regards to automated equipment.
 - 2) Any commissioning or service engineer must be of a competent nature, trained and qualified to the local and national standards required to fulfill that job. These engineers should also be trained in the use and maintenance of the completed product. This includes being completely familiar with all associated documentation for the said product. All maintenance should be carried out in accordance with established safety practices.
 - 3) All operators of the completed equipment should be trained to use that product in a safe and coordinated manner in compliance to established safety practices. The operators should also be familiar with documentation which is connected with the actual operation of the completed equipment.

Note: the term 'completed equipment' refers to a third party constructed device which contains or uses the product associated with this manual

- This product has been manufactured as a general-purpose part for general industries, and has not been designed or manufactured to be incorporated in a device or system used in purposes related to human life.
- Before using the product for special purposes such as nuclear power, electric power, aerospace, medicine or passenger movement vehicles, consult with Mitsubishi Electric.
- This product has been manufactured under strict quality control. However when installing the product where major accidents or losses could occur if the product fails, install appropriate backup or failsafe functions in the system.
- When combining this product with other products, please confirm the standard and the code, or regulations with which the user should follow. Moreover, please confirm the compatibility of this product to the system, machine, and apparatus with which a user is using.
- If in doubt at any stage during the installation of the product, always consult a professional electrical engineer who is qualified and trained to the local and national standards. If in doubt about the operation or use, please consult the nearest Mitsubishi Electric distributor.
- Since the examples indicated by this manual, technical bulletin, catalog, etc. are used as a reference, please use it after confirming the function and safety of the equipment and system. Mitsubishi Electric will accept no responsibility for actual use of the product based on these illustrative examples.
- This manual content, specification etc. may be changed without a notice for improvement.
- The information in this manual has been carefully checked and is believed to be accurate; however, if you have noticed a doubtful point, a doubtful error, etc., please contact the nearest Mitsubishi Electric distributor.

Registration

- Microsoft® and Windows® are either registered trademarks or trademarks of Microsoft Corporation in the United States and/or other countries.
- The company name and the product name to be described in this manual are the registered trademarks or trademarks of each company.

Associated Manuals

Manual name	Manual No.	Description
FX Configurator-EN Operation Manual	JY997D20501 MODEL CODE: 09R919	This manual
FX _{3U} -ENET INSTALLATION MANUAL	JY997D15901	Installation of FX _{3U} -ENET block
FX _{3U} -ENET User's Manual	JY997D18101 MODEL CODE: 09R716	Describes the details of specifications, wiring, installation, maintenance, and operation of FX _{3U} -ENET.
FX _{3U} Series HARDWARE MANUAL	JY997D18801	Extracts the I/O specifications, wiring, and installation of FX _{3U} Series PLC from FX _{3U} Series HARDWARE MANUAL.
FX _{3U} Series User's Manual - Hardware Edition	JY997D16501 MODEL CODE: 09R516	Explains FX _{3U} Series PLC specification details for I/O, wiring, installation, and maintenance.
FX _{3UC} (D, DSS) Series HARDWARE MANUAL	JY997D28601	Extracts the I/O specifications, wiring, and installation of FX _{3UC} Series PLC from FX _{3UC} Series HARDWARE MANUAL.
FX _{3UC} Series User's Manual - Hardware Edition	JY997D28701 MODEL CODE: 09R519	Explains FX _{3UC} Series PLC specification details for I/O, wiring, installation, and maintenance.
FX _{3U} /FX _{3UC} Series Programming Manual - Basic & Applied Instruction Edition	JY997D16601 MODEL CODE: 09R517	Describes PLC programming for basic/applied instructions and devices.

How to obtain manuals

For product manuals or documents, Please contact the Mitsubishi Electric dealer from where you purchased your product.

1. INTRODUCTION	1-1
1.1 Outline of Product.....	1-1
1.2 Product Configuration.....	1-1
1.3 Function.....	1-1
1.4 Compatible Model	1-1
1.5 Operating System Requirements	1-2
1.6 Installation	1-3
1.7 Uninstallation.....	1-3
2. SYSTEM CONFIGURATION	2-1
2.1 Connection from the USB and Serial Port.....	2-1
2.2 Connection from the Ethernet Port.....	2-5
3. STARTING METHOD	3-1
3.1 Starting FX Configurator-EN	3-1
3.1.1 Starting FX Configurator-EN from the start menu	3-1
3.1.2 Starting GX Developer from the tool menu	3-1
3.2 Screen Transition	3-2
3.3 Loading or Saving the Files.....	3-2
4. SETTING THE ETHERNET PARAMETERS	4-1
4.1 Setting the Ethernet.....	4-1
4.2 Operational Settings.....	4-3
4.3 Initial Settings	4-5
4.4 Open Setting	4-7
4.5 Router Relaying Parameter Setting.....	4-11
4.6 E-mail Setting	4-12
4.6.1 E-mail setting	4-12
4.6.2 Send mail address setting.....	4-13
5. ONLINE FUNCTION	5-1
5.1 Designation of Destination to be Connected	5-1
5.2 Remote Operation	5-2
5.3 Reading or Writing Parameters	5-3
5.4 Verifying Parameters.....	5-4
6. ETHERNET DIAGNOSTICS FUNCTION	6-1
6.1 Ethernet Diagnostics Function	6-1
6.2 Parameter Status	6-2
6.3 Error Log	6-3
6.4 Status of Each Connection.....	6-4
6.5 Status of Each Protocol.....	6-5
6.6 LED Status	6-7
6.7 Received E-mail Information	6-8
6.8 Send E-mail Information.....	6-10
6.9 PING Test.....	6-11

7. Appendix	7-1
7.1 Printing parameters	7-1
7.1.1 Printing method	7-1
7.1.2 Printing example	7-2
7.2 Connecting the Ethernet module compatible with MX Component	7-4
7.2.1 System Configuration	7-4
7.2.2 Communication setting wizard for Ethernet communication	7-5
7.2.3 ATC control: ActFxENETTCP and ActMLFxENETTCP controls	7-6

1. INTRODUCTION

1.1 Outline of Product

This product is PC software for setting parameter diagnostics of the FX3U-ENET type Ethernet block (hereinafter referred to as "Ethernet module").

1.2 Product Configuration

SW1D5C-FXENET-E : one CD-ROM

Software license agreement

Manual : one copy (this manual)

1.3 Function

The main functions for FX Configurator-EN are as follows:

- Creation of parameters : Sets each parameter for the Ethernet module.
- Online function : Reads and writes parameters from/to the Ethernet module. In addition, remotely operates the PLC.
- Ethernet diagnostics function: Checks various settings of the Ethernet module.

1.4 Compatible Model

FX3U-ENET type Ethernet block

1.5 Operating System Requirements

The FX Configurator-EN software is designed to be installed on a computer that meets or exceeds the following specifications. Please check whether your personal computer meets these requirements prior to the software installation.



Table: Personal Computer Requirements

Item	Description
OS	Microsoft® Windows® 95 English version (Service Pack 1 or later) Microsoft® Windows® 98 English version Microsoft® Windows® Millennium Edition English version Microsoft® WindowsNT® 4.0 Workstation English version (Service Pack 3 or later) Microsoft® Windows® 2000 English version Microsoft® Windows® XP English version (Home Edition or Professional) Microsoft® Windows Vista® English version (Home Basic, Home Premium, Business, Ultimate or Enterprise)
PC main body	Microsoft® Windows® 95: CPU Pentium133MHz or better one Microsoft® Windows® 98: CPU Pentium133MHz or better one Microsoft® Windows® Millennium Edition: CPU Pentium 150 MHz or better one Microsoft® WindowsNT® 4.0: CPU Pentium133MHz or better one Microsoft® Windows® 2000: CPU Pentium133MHz or better one Microsoft® Windows® XP: CPU Pentium 300MHz or better one Microsoft® Windows Vista®: CPU Pentium 1GHz or better one
Required memory	Microsoft® Windows® 95: 64 MB or more Microsoft® Windows® 98: 64 MB or more Microsoft® Windows® Millennium Edition: 32 MB or more Microsoft® WindowsNT® 4.0: 64 MB or more Microsoft® Windows® 2000: 64 MB or more Microsoft® Windows® XP: 128MB or more Microsoft® Windows Vista®: 1GB or more
Hard disk capacity	Free space of 150 MB or more
Disk drive	For installing the software
Display	Video display adaptor whose resolution is SVGA (800 × 600) *1
Interface	RS-232C port, USB port, Ethernet board
Printer	Printer in accordance with the OS above
Others	Mouse or other pointing device

*1 When using Windows Vista®, the recommended resolution is 1024 × 768 or more.

1.6 Installation

- 1 Insert the FX Configurator-EN CD-ROM into the CD-ROM drive.
- 2 Execute SETUP.EXE in the CD-ROM.
- 3 Follows the guidance on the PC display to complete the installation.

Caution

FX Configurator-EN requires the following version of GX Developer (SW□D5C-GPPW-E) or later.

FX Configurator-EN must be reinstalled if it was first instead prior to the applicable version of GX Developer.

Operating System	GX Developer (SW□D5C-GPPW-E) version
Windows [®] 95, Windows [®] 98, Windows [®] Millennium Edition, WindowsNT [®] 4.0, Windows [®] 2000, Windows [®] XP	Ver. 8.25B or later
Windows Vista [®]	Ver. 8.62Q or later

1.7 Uninstallation

- 1 Click [Add or Remove Programs] in the control panel.

Note

- Double-click [Add/Remove Programs] on the control panel in Windows[®] 95, Windows[®] 98, Windows[®] Millennium Edition, WindowsNT[®] 4.0, Windows[®] 2000.
- [Programs] appears in Windows Vista[®].

- 2 Select [Change or Remove Programs] in [Add or Remove Programs] window.

Note

- Click [Add/Remove] on [Add/Remove Programs] property in Windows[®] 95, Windows[®] 98, Windows[®] Millennium Edition and WindowsNT[®] 4.0.
- Click [Change or Remove Programs] in [Add/Remove Programs] in window in Windows[®] 2000.
- Double-click [Uninstall a program] of [Programs and Features] in Windows Vista[®].

- 3 Click [FX Configurator-EN] to uninstall.

Note

Double-click [FX Configurator-EN] to uninstall in Windows Vista[®], and go to step 5.

- 4 Click [Change/Remove] button.

- 5 Follow the guidance on the PC display to complete the uninstallation.

MEMO

2. SYSTEM CONFIGURATION

2.1 Connection from the USB and Serial Port

The following system configurations illustrate the possible connections from the serial port or USB of a personal computer to the FX3U/FX3UC.

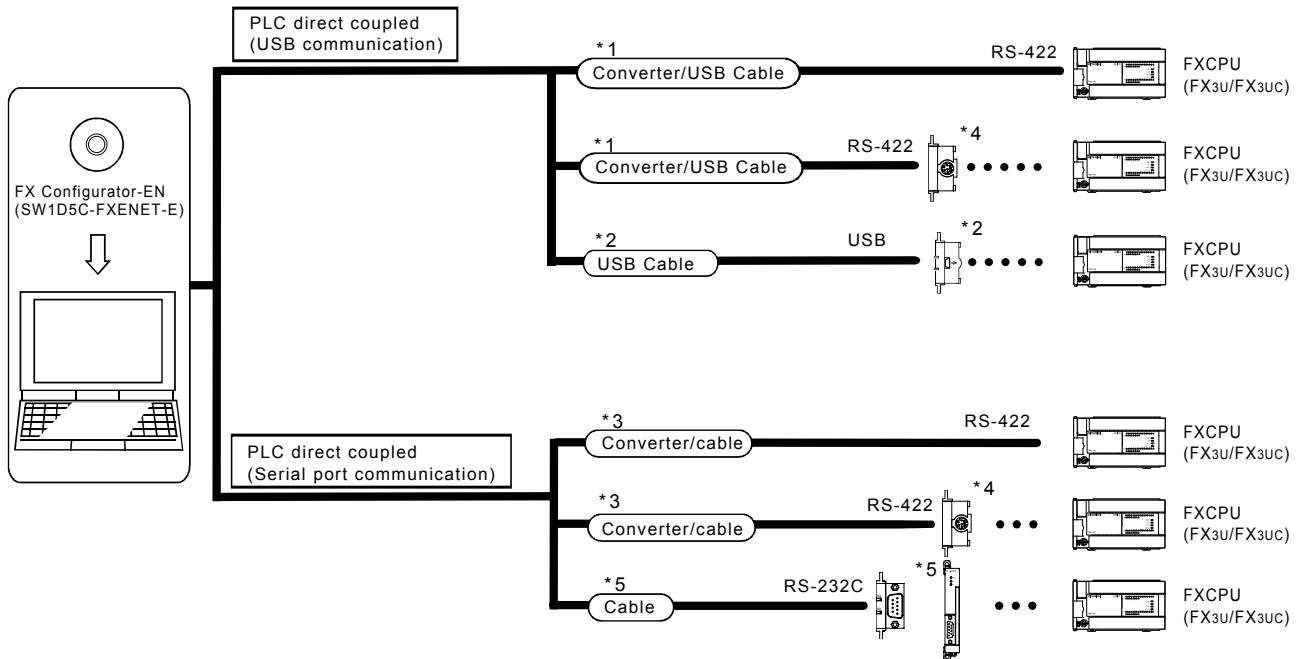

When the Ethernet parameters are written for the first time, they (FX Configurator-EN data) are written using the programming port of the main unit PLC.

*1 About the converter / cable

1) System configuration

FX-USB-AW

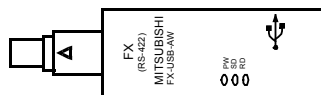

USB cable (packed)



- 2) The converter / cable may be used if the driver on the CD-ROM that is packed with the FX-USB-AW and FX_{3U}-USB-BD has been installed. For the applicable Windows® Operating System, refer to the respective manual.
- 3) On GX Developer, choose [Online] - [Transfer setup] and set the serial COM port number.
- 4) For precautions and restrictions on the use of the FX-USB-AW, refer to the manual packed with the FX-USB-AW.

*2 USB cable and function expansion board

1) System configuration

FX3U-USB-BD

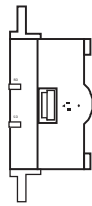

USB cable (packed)



The FX_{3U}-USB-BD can not be attached to the FX_{3UC}-□□MT/D and FX_{3UC}-□□MT/DSS PLC.

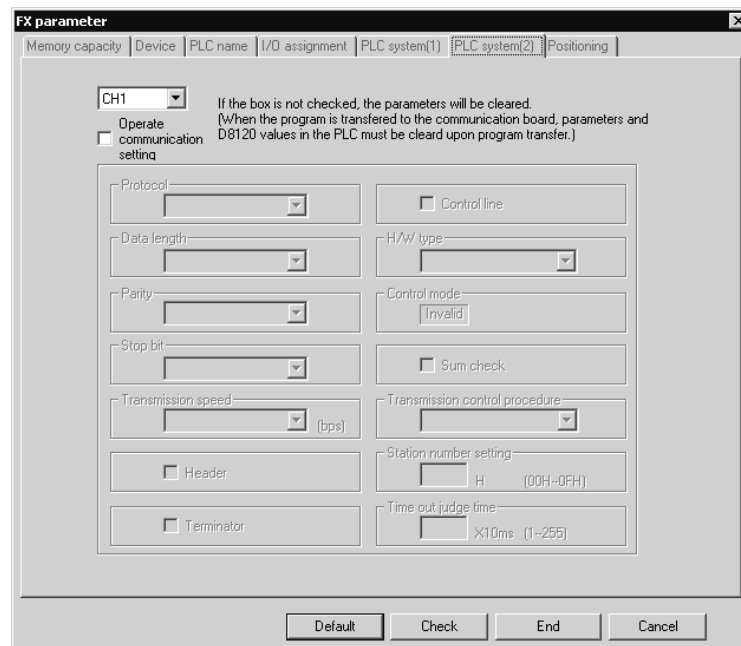

- 2) If “Operate communication setting” is checked on the [PLC System (2)] tab in the [PLC Parameter] dialog box within GX Developer, the corresponding port cannot be used for communication with the PLC. In this case, clear the setting and download the updated information to the PLC via the built-in RS-422 programming port on the PLC.



When the PLC type of the project is the FX3U(C), the channel specification (CH1/CH2) combo box is displayed. Set to CH1 and check the settings.

- 3) The USB cable and function expansion board are available if the driver on the CD-ROM that is packed with the FX-USB-AW and FX_{3U}-USB-BD has been installed. For the applicable Windows® Operating System, refer to the respective manual.
- 4) On GX Developer, set the serial COM port number by choosing [Online] - [Target setup].
- 5) For the precautions and restrictions on use of the FX_{3U}-USB-BD, refer to the manual packed with the FX_{3U}-USB-BD.

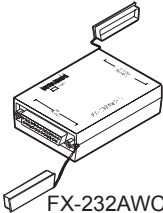
*3 About the converter / cable

Personal computer Side (RS-232C cable)	RS-232C / RS-422 Converter	PLC CPU Side (RS-422 cable)
 F2-232CAB-1 (when Personal computer connector is D-sub, 9-pin)	 FX-232AWC-H	 FX-422CAB0 (1.5m)

*4 Expansion board

Series	Expansion board
FX3U, FX3UC	FX3U-422-BD

The FX3U-422-BD can not be attached to the FX3UC-□□MT/D and FX3UC-□□MT/DSS PLC.

If “Operate communication setting” is checked on the [PLC System (2)] tab in the [PLC Parameter] dialog box within GX Developer, the corresponding port cannot be used for communication with the PLC. In this case, clear the setting and download the updated information to the PLC via the built-in RS-422 programming port on the PLC.

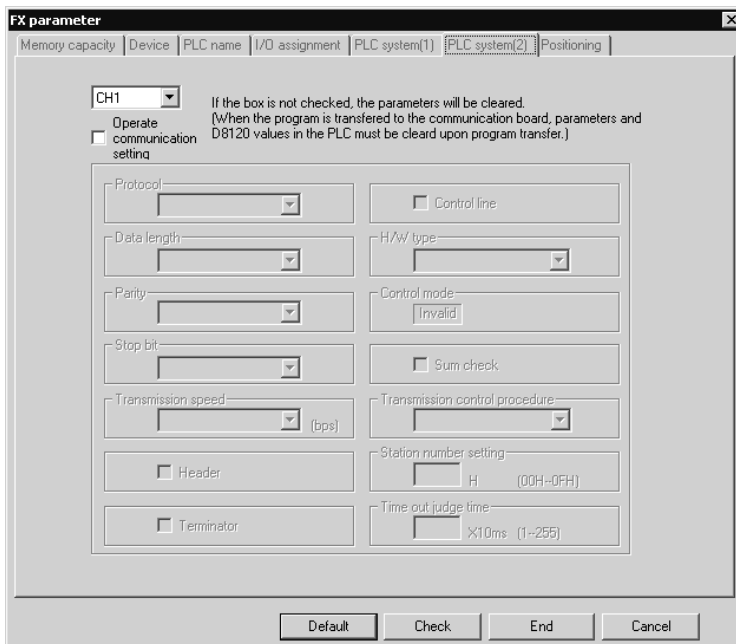

When the PLC type of the project is the FX3U(C), the channel specification (CH1/CH2) combo box is displayed. Set to CH1 and check the settings.

*5 RS-232 cable and expansion board/special adaptor

Serial port shape of personal computer	Series	Required expansion board and special adaptor	RS-232C cable
D sub 9 pin	FX3U FX3UC	FX3U-232-BD	FX-232CAB-1
		Function expansion board (FX3U-***-BD) + FX3U-232ADP	

*** of the function expansion board (FX3U-***-BD) indicates 232, 485, 422, USB or CNV. The FX3UC-□□MT/D and FX3UC-□□MT/DSS PLC can be attached to the FX3U-232ADP without an expansion board (FX3U-***-BD).

If “Operate communication setting” is checked on the [PLC System (2)] tab in the [PLC Parameter] dialog box within GX Developer, the corresponding port cannot be used for communication with the PLC. In this case, clear the setting and download the updated information to the PLC via the built-in RS-422 programming port on the PLC.

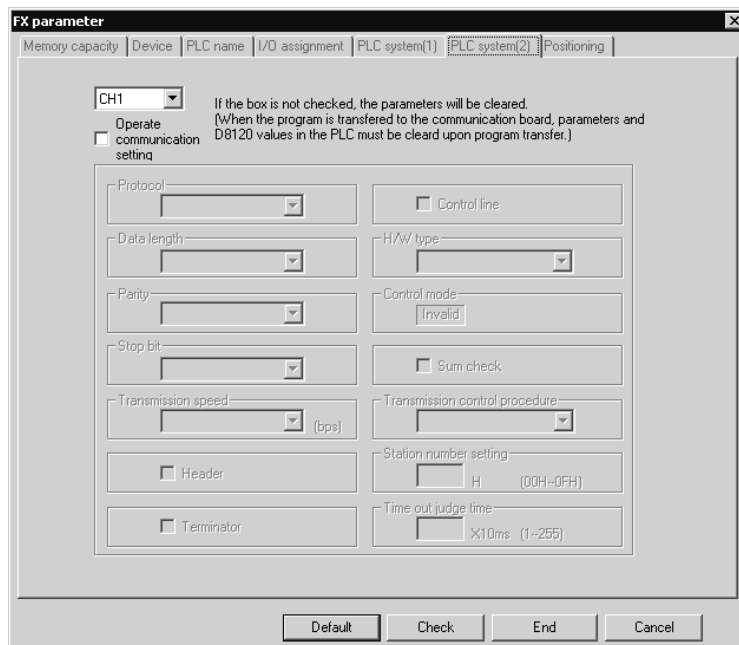

When the PLC type of the project is the FX3U(C), the channel specification (CH1/CH2) combo box is displayed.

When using the FX3U-232-BD or the first FX3U-232ADP connected to the FX3U-CNV-BD, set CH1 and check the settings.

When using the FX3U-232ADP connected to other than the FX3U-CNV-BD or the second FX3U-232ADP connected to the FX3U-CNV-BD, set CH2 and check the settings.

2.2 Connection from the Ethernet Port

the following system configuration is made up by connection from the Ethernet port.

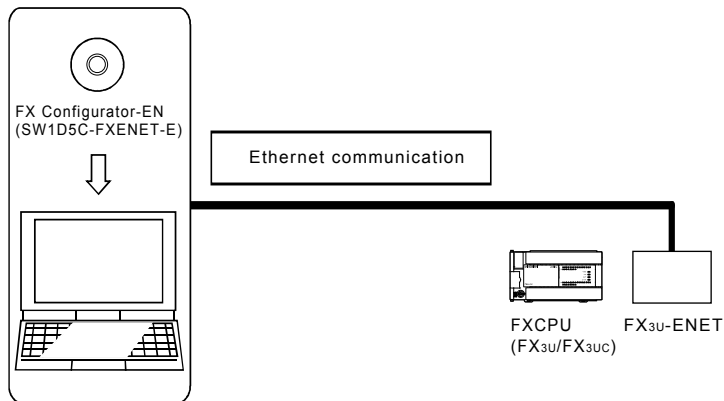

When the Ethernet parameters are written for the first time, the Ethernet parameters (FX Configurator-EN data) are written using the programming port of the main unit of PLC.

MEMO

3. STARTING METHOD

3.1 Starting FX Configurator-EN

To start FX Configurator-EN, the following methods are available:

3.1.1 Starting FX Configurator-EN from the start menu

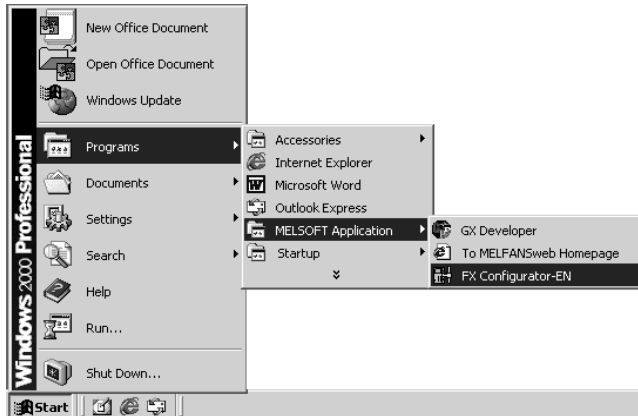

1) Click on [Start] and move the cursor onto [Programs] then onto [MELSOFT Application] menus.

* When Windows® XP (Professional or Windows® XP Home Edition) or Windows Vista® (Home Basic, Home Premium, Business, Ultimate or Enterprise) is used, [All programs] is displayed.

2) Click on the [FX Configurator-EN] menu.

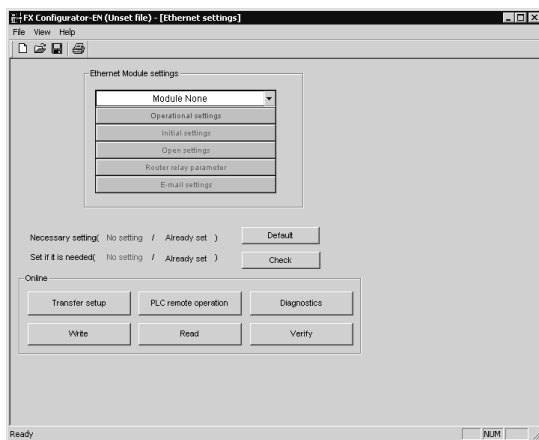
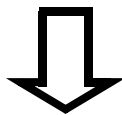

3) FX Configurator-EN will start up.

3.1.2 Starting GX Developer from the tool menu

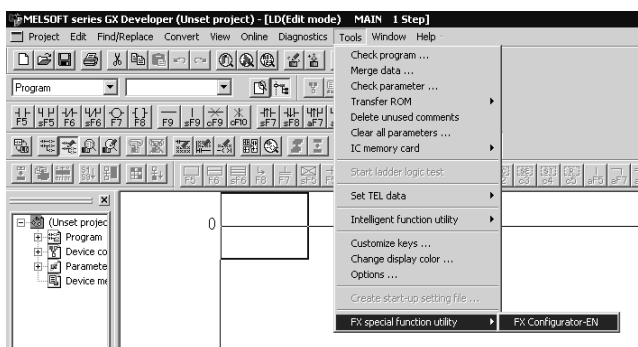

1) Select [Tools] of the GX Developer, [FX special function utility] and [FX Configurator-EN] menus to start FX Configurator-EN.

3.2 Screen Transition

The screen transition of FX Configurator-EN is shown below.

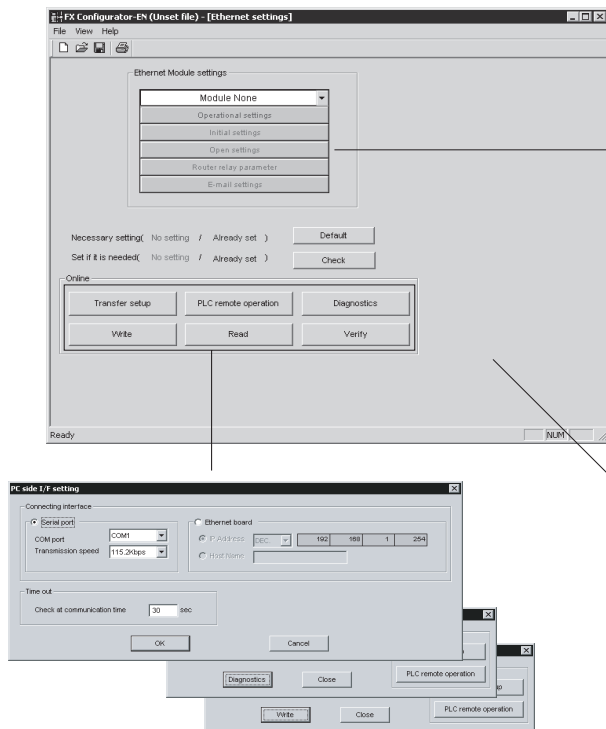

Ethernet module parameters setting (See Chapter 4.) Sets the parameters to operate the Ethernet module.

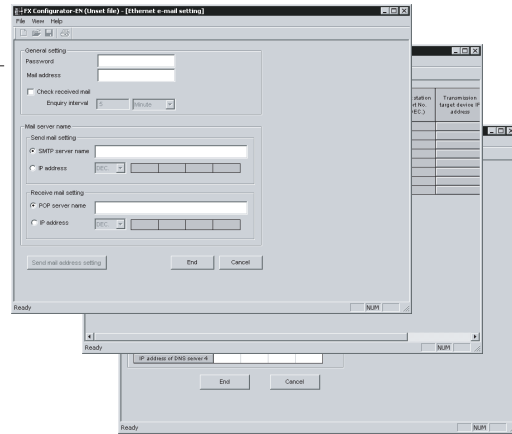

Ethernet diagnostics function (See Chapter 6.) Various settings of the Ethernet module can be checked.

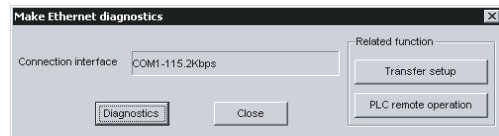

Online function (See Chapter 5.) Reads or writes parameters from/to the Ethernet module, specifies the PLC to be connected, or remotely operates the PLC.

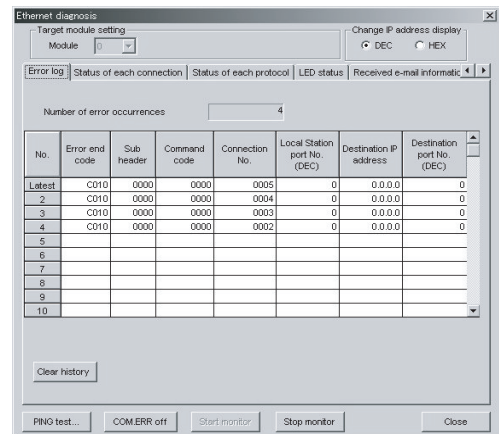

3.3 Loading or Saving the Files

The settings of parameters specified by FX Configurator-EN can be saved in a file (file form: .fen).

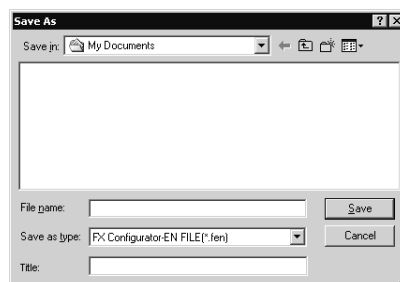

4. SETTING THE ETHERNET PARAMETERS

4.1 Setting the Ethernet

[Purpose of setting]

This setting enables the Ethernet module to be used as a network module. It also serves as the main screen where [Operational settings], [Initial settings] etc., are performed to use the Ethernet module.

[Operating procedure]

Start FX Configurator-EN from the [Tools] menu of GX Developer or from the Windows start menu to display this screen.

[Setting screen]

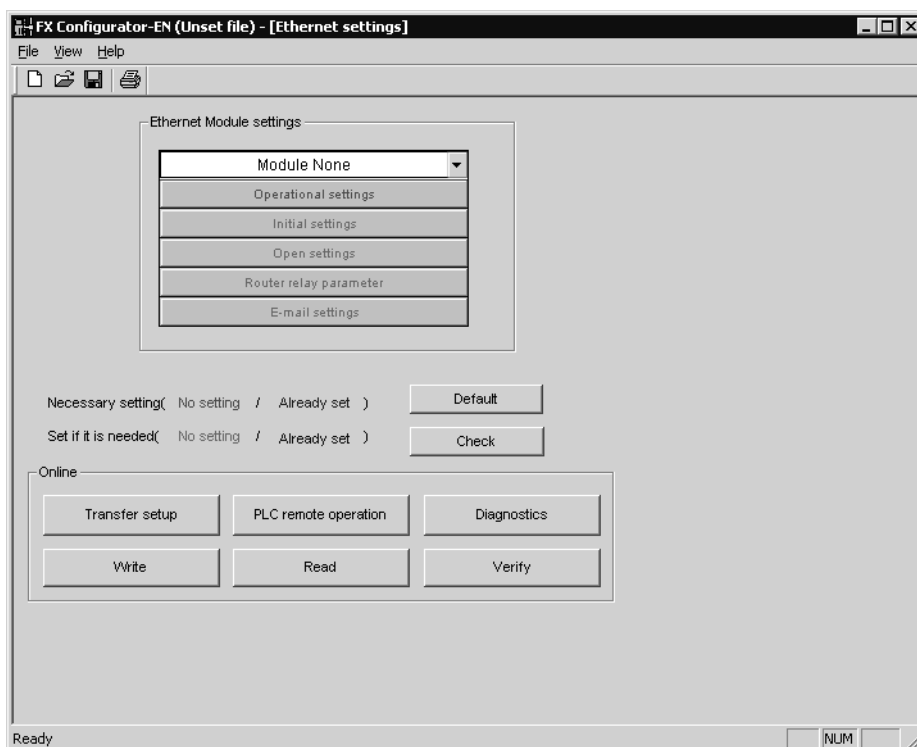

Item name	Description of setting
Module None	Select the number of the Ethernet module to be set. No module designation *1 *2 Modules 0 to 7
Operational settings (Detailed description: Section 4.2)	Set the common items of the Ethernet module.
Initial settings (Detailed description: Section 4.3)	Set the timer values for data communications.
Open settings (Detailed description: Section 4.4)	Set the open process or the close process of connection.

Item name	Description of setting
Router relay parameter (routing information) (Detailed description: Section 4.5)	Specify the setting for taking communications via the router.
E-mail settings (Detailed description: Section 4.6.1)	Specify the setting for sending or receiving e-mail.
E-mail address setting (Detailed description: Section 4.6.2)	Set the sending destination mail address to send an e-mail.

*1 The Ethernet module corresponding to the smallest module number among the PLCs connected is set for FX Configurator-EN.

*2. Can be set only when remotely-operating the PLC or reading parameters.

4.2 Operational Settings

[Purpose of setting]

Set the common items of the modules to use the Ethernet module.

Ensure this setting is specified since it is necessary for initializing the Ethernet module.

[Operating procedure]

Select [Ethernet settings] of FX Configurator-EN → Operational settings

[Setting screen]

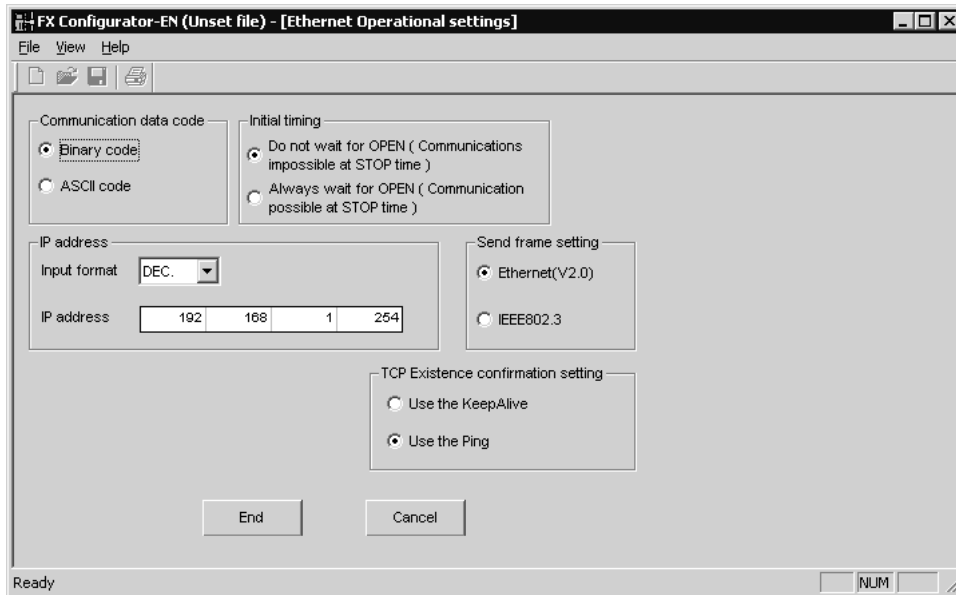

Item name	Description of setting
Communication data code	Select the communication data code with an external device when using a fixed buffer or MC protocol for communications. <ul style="list-style-type: none"> - Binary code communications: Communicate using a binary code. - ASCII code communications: Communicate using ASCII data.
Initial timing	Select the timing to open for connections for which TCP-Passive open or UDP open are selected with the "Open settings" (See Section 4.4). <ul style="list-style-type: none"> - Do not wait for OPEN <ul style="list-style-type: none"> : Execute open/close processing using a sequence program. When using an MC protocol for communications, communication can not be performed while the PLC is in the STOP status. - Always wait for OPEN <ul style="list-style-type: none"> : Passive open and UDP open connections always wait for open according to the parameter settings (a sequence program for open/close processing is not required). When using an MC protocol for communications, communication can be performed while the PLC is in the STOP status.

Item name		Description of setting
IP address	Input format	Select the IP address input format. - Decimal - Hexadecimal
	IP address	Set the IP address of the local station.
Send frame setting		Select the frame of the Ethernet header for the data link layer to be sent by the Ethernet module. - Ethernet (V2.0) :Transmits using an Ethernet frame. - IEEE802.3 :Transmits using an IEEE802.3 frame.
TCP Existence setting		Select the existence check method for TCP protocol communications. - Use the KeepAlive : Checks connection status with KeepAlive. - Use the Ping : Checks connection status with Ping.

4.3 Initial Settings

[Purpose of setting]

Set the minimum parameters necessary for exchanging data to the Ethernet module, allowing data exchange with external device.

[Operating procedure]

[Ethernet setting] of EX Configurator-EN → Initial settings

[Setting screen]

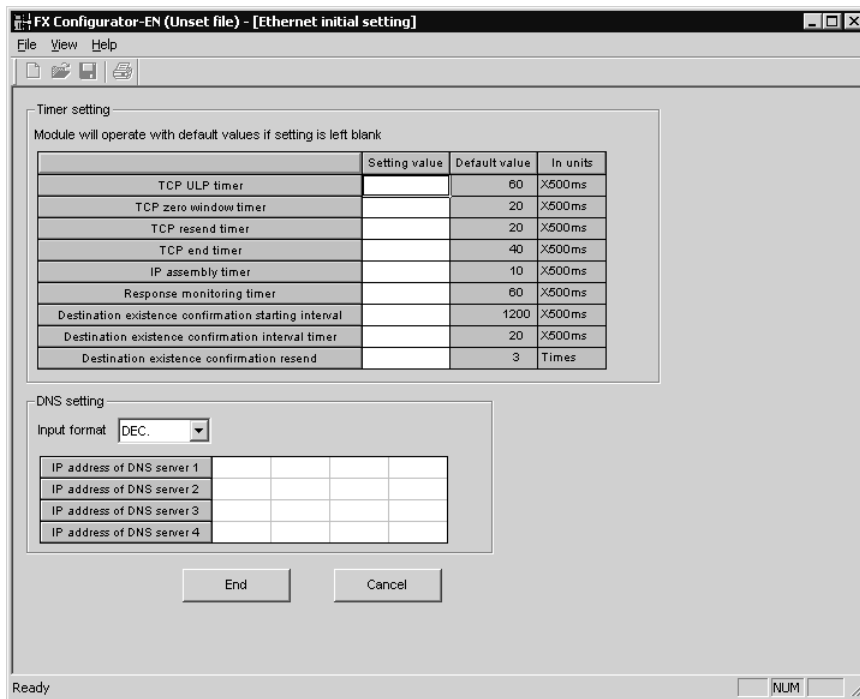

Item name		Description of setting
Timer setting	TCP ULP timer	Set the time of packet existence (2 to 32767) at ICP data transmission.
	TCP zero window timer	Set the interval for checking the reception enabled status (2 to 32767).
	TCP resend timer	Set the time (2 to 32767) to resend at TCP data transmission.
	TCP end timer	Set the confirmation wait time (2 to 32767) at TCP close processing.
	IP assembly timer	Set the wait time (1 to 32766) for division data packets.
	Response monitoring timer	Set the response wait time (2 to 32767).
	Destination existence confirmation starting interval	Set the time (1 to 32767) to start confirming existence of a destination device after communication with the device has terminated.
	Destination existence confirmation interval timer	Set the time interval (1 to 32767) between confirming existence.
	Destination existence confirmation resend	Set the number of times to reconfirm existence when a response to the existence confirmation is not received.

	Item name	Description of setting
DNS setting		Specify this setting for sending or receiving an e-mail. Designate the IP address of the domain name server (DNS) specified by the Ethernet module.
	Input format	Select IP address input format (decimal/hexadecimal) of DNS server.
	IP address of DNS server 1	Set IP address of DNS server 1.
	IP address of DNS server 2	Set IP address of DNS server 2.
	IP address of DNS server 3	Set IP address of DNS server 3.
	IP address of DNS server 4	Set IP address of DNS server 4.

POINT	
	<p>1) The DNS server controls the network. DNS setting is necessary when the SMTP server and the POP3 server are searched for from the domain name.</p> <p>2) Use the DNS setting to specify the mail server name as a domain name. (See Section 4.6.) If the IP address is used to specify the mail server name, the setting is unnecessary.</p> <p>3) To acquire the IP address from the domain name, search the DNS servers from the first one in order.</p>

4.4 Open Setting

[Purpose of setting]

Set the open processing or close processing for each connection.

IMPORTANT

If "Always wait for OPEN (Communication possible at STOP time" is selected on the Operational Settings screen (see Section 4.2), be sure to set parameters on this screen for a connection for which Passive open or UDP open is selected for communications.

[Operating procedure]

Select [Ethernet Settings] of FX Configurator-EN → Open settings

[Setting Screen]

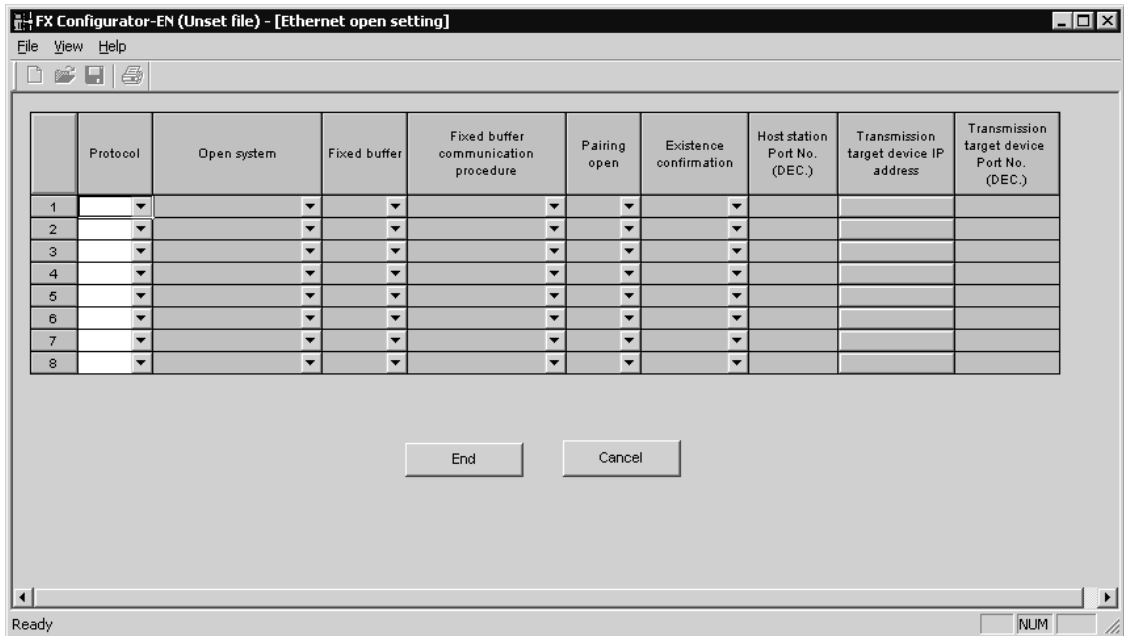

Item name	Description of setting
Protocol	Select a protocol for each connection. - TCP/IP : Communicate using TCP/IP. - UDP/IP : Communicate using UDP/IP.

Item name	Description of setting
Open system	<p>Select the open system for each connection for which "TCP" is selected in "Protocol". (If "UDP" is selected, the specification of this item is not required.)</p> <p>Active : Perform active open processing to an external device that waits for a passive open (Full passive/Unpassive) on the TCP connection.</p> <p>Unpassive : Perform passive open processing on the TCP connection addressing all the devices connected to a network. (The local station is placed in the wait status to wait for an Active open request to be sent.)</p> <p>Full passive : Perform passive open processing on the TCP connection, only addressing specific devices. (The local station is placed in the wait status to wait for an Active open request to be sent.)</p> <p>MELSOFT connection *1*2*3 : Used to connect MELSOFT products via TCP/IP communication. Perform passive open processing on the TCP connection, addressing all the MELSOFT products connected to a network.</p>
Fixed buffer	<p>Select whether the fixed buffer corresponding to each applicable connection will be used for sending or receiving.</p> <p>- Send : For sending / fixed buffer communication is not used - Receive : For receiving</p>
Fixed buffer communication	<p>Select the communication method when communicating using the fixed buffers.</p> <p>- Procedure exist : Data is communicated in 1:1 by handshaking with the external device.</p> <p>-Procedure exist (MC) : Select to use the MC protocol for communications. Data is communicated in 1:1 by handshaking with the external device.</p> <p>- No procedure : The No procedure fixed buffer communication uses dedicated connections. The PLC and external devices communicate data in 1:1. The handshaking with an external device must be performed using a sequence program.</p>
Pairing open	<p>Select whether or not the Ethernet module's receiving and sending connections are made into one pair and connected to one port of an external device (only when using fixed buffer communication).</p> <p>- No pairs - Pairs</p>
Existence confirmation *4	<p>Select whether or not to confirm the existence of the external device.</p> <p>- No confirm - Confirm</p>
Local station Port No.	<p>Set the local station port number (1025 to 5548 or 5552 to 65534) (in decimal).</p>
Destination IP address	<p>Select the IP address of an external device (in decimal/hexadecimal).</p>
Destination Port No.	<p>Set the port numbers of the external devices (1025 to 65535) (in decimal).</p>

- *1. Regardless of the initial timing setting in the operation setting (refer to Section 4.2), this connection will always wait for the open status.
- *2. The set connection is dedicated to data communication with the MELSOFT products.
- *3. When simultaneously connecting to multiple MELSOFT products, set the connections as many as the number of MELSOFT products.
Up to four connections can be set.
However, when setting [Fixed buffer communication procedure] in the open settings to [Procedure exist (MC)], the number of connections decreases by the number set in the [Procedure exist (MC)].
$$\text{Number of connections to MELSOFT products} + \text{Number set in [Procedure exist (MC)]} \leq 4$$
- *4. If the external device will be changed while a UDP/IP connection is open, select "No confirm."
If "Confirm" is selected, the Ethernet module will confirm the existence of the first destination after the UDP/IP connection is opened. Existence confirmation is not performed for the changed destination, i.e. the newly selected external device.

POINT

1) Set parameters according to the open method to be used for open connection.

Communication system open system Parameter		TCP				UDP	
		Active		Passive		ARP function of external device	
		ARP function of external device		Unpassive	Fullpassive		
		Yes	No			Yes	No
Communication address	Local station Port No.	<input type="radio"/>	<input type="radio"/>	<input type="radio"/>	<input type="radio"/>	<input type="radio"/>	<input type="radio"/>
	Destination IP address	<input type="radio"/>	<input type="radio"/>	<input checked="" type="radio"/>	<input type="radio"/>	<input type="radio"/>	<input type="radio"/>
	Destination Port No.	<input type="radio"/>	<input type="radio"/>	<input checked="" type="radio"/>	<input type="radio"/>	<input type="radio"/>	<input type="radio"/>
	Destination Ethernet address (*2)	<input type="radio"/> (*1)	<input type="radio"/>	<input checked="" type="radio"/>	<input checked="" type="radio"/>	<input type="radio"/> (*1)	<input type="radio"/>

*1 Use the default value (FFFFFFFFFH) or "0".

*2 When using the "Open settings" of FX Configurator-EN, the default value is used.

2) Setting example for using pairing to communicate

The screen for pairing communication with FX Configurator-EN is shown below.

The screenshot shows the 'FX Configurator-EN' window with the title 'D:\Documents and Settings\W927\Desktop\ether_data.fen - [Ethernet open settings]'. The main area contains a table with the following columns: Protocol, Open system, Fixed buffer, Fixed buffer communication procedure, Pairing open, Existence confirmation, Host station Port No. (DEC.), Transmission target device IP address, and Transmission target device Port No. (DEC.).

	Protocol	Open system	Fixed buffer	Fixed buffer communication procedure	Pairing open	Existence confirmation	Host station Port No. (DEC.)	Transmission target device IP address	Transmission target device Port No. (DEC.)
1	TCP	Unpassive	Receive	Procedure exist	Enable	No confirm	1280		
2	TCP	Unpassive	Send	Procedure exist	Enable	No confirm	1280		
3									
4									
5									
6									
7									
8									

Buttons: End, Cancel

Ready NUM

- Use connection No. 1 or No. 2.
(If connection No. 1 is set, connection No. 2 is automatically used.)
- The Ethernet module's port number is 1280.
- The open system is an Unpassive open system.

4.5 Router Relaying Parameter Setting

[Purpose of setting]

Specify this setting for relaying the router to gain additional communication.

[Operating procedure]

Select [Ethernet settings] of FX Configurator-EN → [Router relay parameter]

[Setting screen]

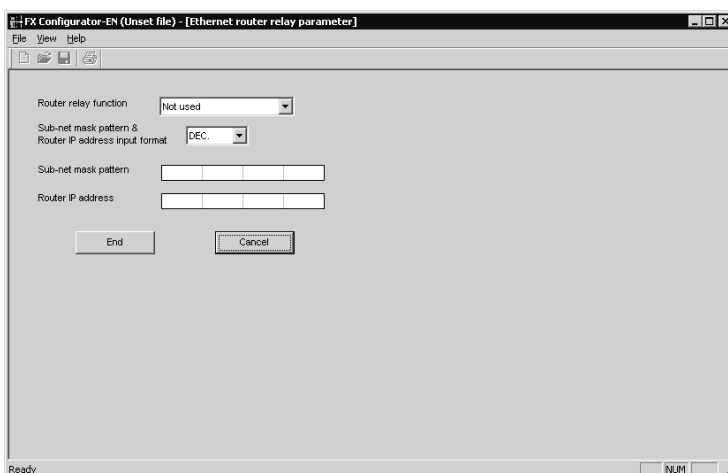

Item name	Description of setting
Router relay function	Set whether the router relay function will be used or not. - Used : The router relay function is used. Communications can be made with an external device on the other Ethernet module via a router or gateway. - Not used : The router relay function is not used. To communicate with an external device on the same Ethernet module (same sub-net address of IP address), the router relay function is unnecessary.
Sub-net mask pattern & router IP address input format	Select the input format (decimal or hexadecimal) for each setting item.
Subnet mask pattern *1	Set the subnet mask.
Router IP address	Set the IP address of the target router to be used. Set the value that satisfies the following conditions. - Condition 1 : The IP address class is any of A, B or C. - Condition 2 : The sub-net address of the default router is the same as that of the local station Ethernet module. - Condition 3 : The host address bits are not all "0" or all "1."

*1. When not using the subnet mask, set any of the following table values according to the class.

Class	Mask value
Class A	FF000000H
Class B	FFFF0000H
Class C	FFFFFF00H

4.6 E-mail Setting

4.6.1 E-mail setting

[Purpose of setting]

Use this setting for enabling e-mail functionality.

[Operating procedure]

Select [Ethernet settings] of FX Configurator-EN → E-mail settings

[Setting screen]

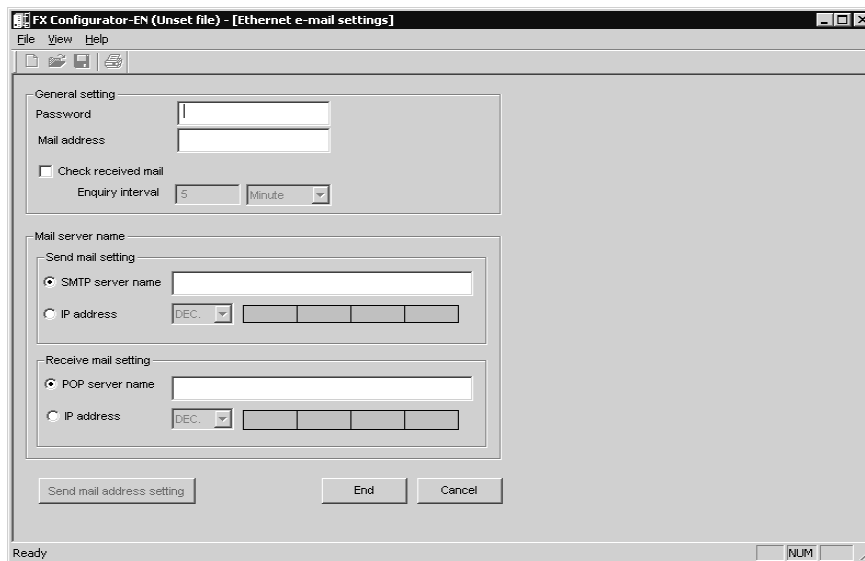

Item name		Discription of setting	
General setting	Password	Set the password to the mail server (16 characters or less).	
	Mail address	Set the mail address for the Ethernet module (64 characters or less).	
	Check received mail	Select whether or not to query the incoming mail server for new messages. - Check mark : Inquire - No check mark : Do not inquire	
	Enquiry interval	Set the time interval (30 s to 24 h) and unit (h/min/s) for making inquiries to the incoming mail server. (Default: 5 min.)	
Mail server name	Send mail setting	SMTP servername	Specify the domain address (64 characters or less) or IP address of the server.
		Input format	- Select the input format (decimal or hexadecimal) of the send mail server's IP address.
		IP address	Set the IP address (00000001 _H to FFFFFFFF _H) of send mail server.
	Receive mail setting	POP server name	Set the receive mail server name (64 characters or less).
		Input format	- Select the input format (decimal or hexadecimal) of the receive mail server's IP address.
		IP address	Set the IP address (00000001 _H to FFFFFFFF _H) of receive mail server.

POINT	<p>If the inquiry time interval from the PLC or other module to the server is short because of the POP3 server specifications, access may be restricted (lock status) on the server side. Check the POP3 server specifications, and set the inquiry time interval accordingly. (It is recommended to set the setting value of the inquiry time interval to the default (5 minutes) or more.)</p>
--------------	--

4.6.2 Send mail address setting

[Purpose of setting]

Register the e-mail address of the external devices where e-mail is to be sent.

[Operating procedure]

Select [Ethernet settings] of FX Configurator-EN

→ E-mail settings → Send mail address setting

[Setting screen]

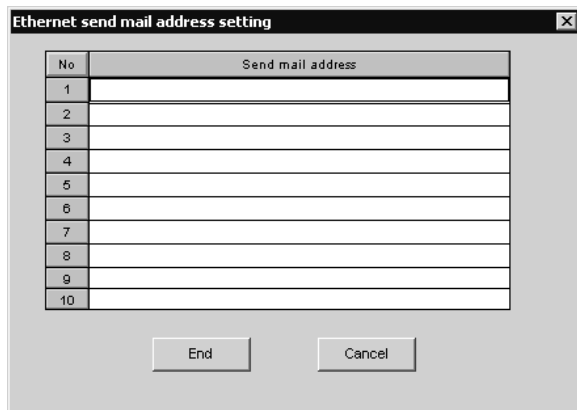

Item name	Description of setting
Send mail address	Set the mail address of the transmission destination (64 characters or less).

POINT	<ul style="list-style-type: none"> - Designate the mail addresses of up to 10 external devices to which mails are sent from the local station's Ethernet module. (Only one e-mail address can be specified for each area.) - In the send e-mail address setting, set up e-mail addresses consecutively starting from No. 1. To delete an e-mail address with a mid-setting number, specify dummy e-mail address in its place. (If an e-mail address is preceded by an empty address area(s), it will be shifted to fill the lowest No. unoccupied address. This will cause the setting numbers to change.)
--------------	--

MEMO

5. ONLINE FUNCTION

5.1 Designation of Destination to be Connected

[Purpose of setting]

Designate the PLC to be connected using FX Configurator-EN.

[Operating procedure]

Select [Ethernet settings] of FX Configurator-EN

→ Transfer setup

[Setting screen]

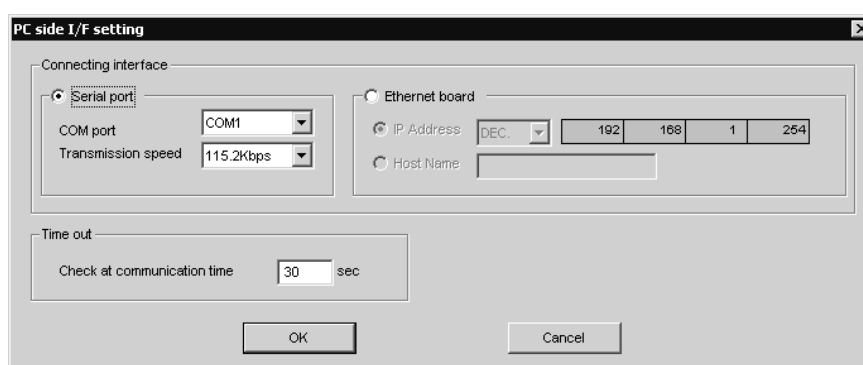

Item name		Description of setting
Serial Port		Select this setting when directly connecting to the PLC using an RS232C/RS422 cable.
Com Port		Select the port (COM1 to 10) for the PC being connected to the PLC.
Transmission Speed *1		Set the transmission speed of the PC and the PLC. Set according to the PC being used.
Ethernet Board		Select this setting when connecting via the Ethernet module to the PLC.
Ip Address		Set the IP address assigned to the PLC being connected.
Host Name		Set the name specified in the host's file (64 characters or less).
Time Out	Check At Communication Time	Set the time out time with the PLC.

*1 At 115.2/57.6 kbps, high-speed communication is not possible unless the PC being used is compatible with the baud rate of 115.2/57.6 kbps. If communication retry is causing a delay in communication or a communication error results, lower the baud rate setting and perform communication again.

5.2 Remote Operation

[Purpose of setting]

Control the PLC operation state using FX Configurator-EN.

[Operating procedure]

Select [Ethernet settings] of FX Configurator-EN → PLC remote operation

[Setting screen]

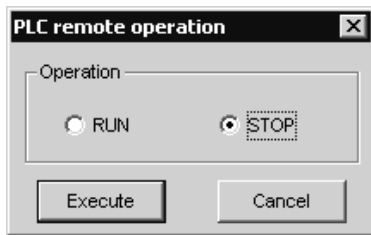

Item name	Description of setting
Operation	RUN : Run the PLC. STOP : Stop the PLC.
Execute button	Execute the remote operation.

5.3 Reading or Writing Parameters

[Purpose of setting]

Read or write parameters from/to the PLC.

[Operating procedure]

Select [Ethernet settings] of FX Configurator-EN → /

[Setting screen]

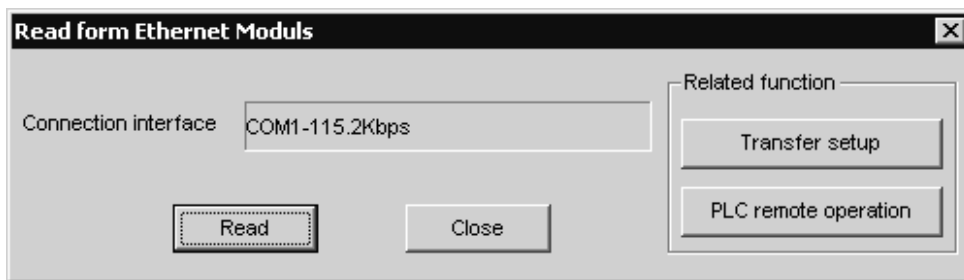

(When reading parameters)

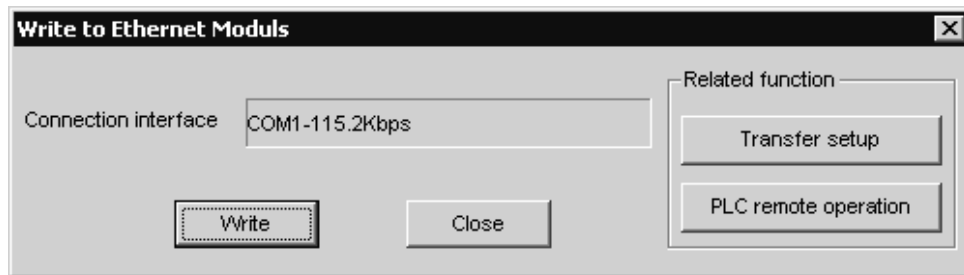

(When writing parameters)

Item name	Description of setting
Connection interface	Displays the connection destination from the connection destination designation screen (refer to Section 5.1).
<input type="button" value="Read"/> button	Read parameter data.
<input type="button" value="Write"/> button	Write parameter data.
<input type="button" value="Transfer setup"/> button	Displays the connection designation screen (refer to Section 5.1).
<input type="button" value="PLC remote operation"/> button	Displays the PLC remote operation screen (refer to Section 5.2).

5.4 Verifying Parameters

[Purpose of setting]

Compare and verify parameters of the PLC with the FX Configurator-EN data.

[Operating procedure]

Select [Ethernet settings] of FX Configurator-EN → **Verify**

[Setting screen]

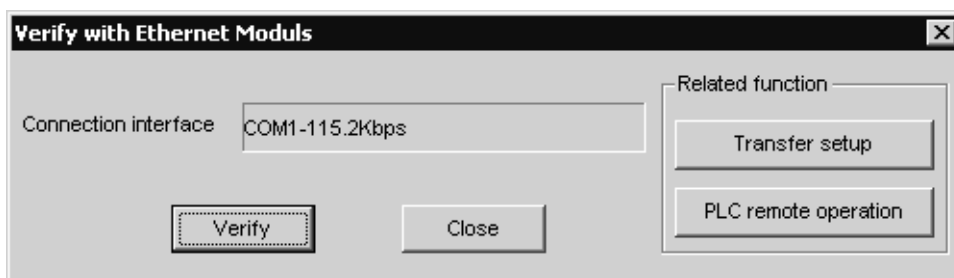

Item name	Description of setting
Connection interface	Displays the connection destination from the connection destination designation screen (refer to Section 5.1).
Verify button	Compare and verify parameters of the connected PLC with the FX Configurator-EN data.
Transfer setup button	Displays the connection designation screen (refer to Section 5.1).
PLC remote operation button	Displays the PLC remote operation screen (refer to Section 5.2).

6. ETHERNET DIAGNOSTICS FUNCTION

6.1 Ethernet Diagnostics Function

[Purpose of setting]

You can check the parameter status, error log, status of each connection, status of each protocol, LED status, received e-mail information and sent e-mail information.

[Operating procedure]

Select [Ethernet settings] of FX Configurator-EN

→ Diagnostics → Diagnostics

[Setting screen]

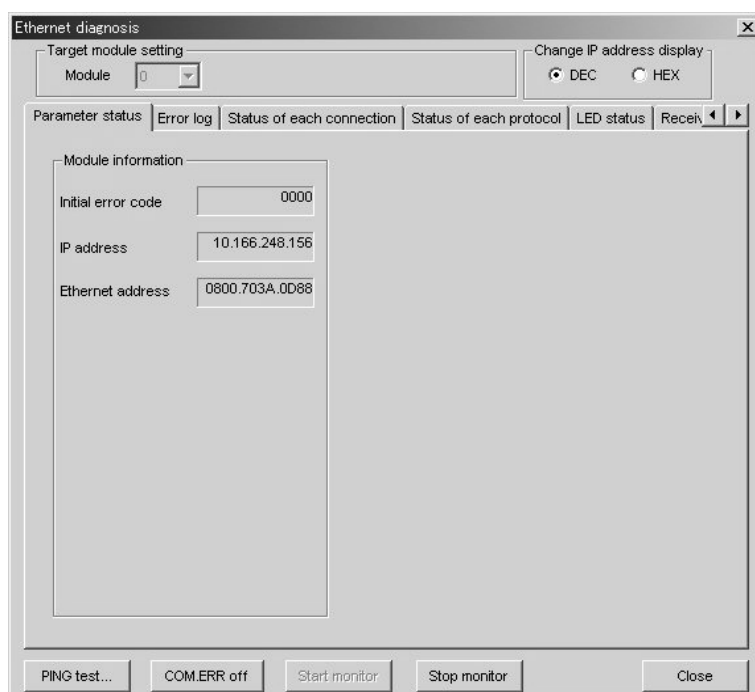

Item name	Description of setting
Target module setting	Specify the Ethernet module to be monitored.
Change IP address display	Change the IP address indication between decimal and hexadecimal.
Selection of various information monitors	Various information on the Ethernet module can be monitored. For details of various information, refer to Section 6.2 to 6.8.
PING test button	Used to perform a PING test on the equipment on the other end. (Refer to Section 6.9.)
COM ERR off button	Click this button to turn off the [COM ERR] LED.
Start monitor button	Click this button to start Ethernet diagnostics. The display is updated during monitoring.
Stop monitor button	Click this button to stop Ethernet diagnostics. The display is held during monitoring stop.

6.2 Parameter Status

[Purpose of setting]

Monitors the parameter status of the Ethernet module.

[Operating procedure]

Select [Ethernet settings] of FX Configurator-EN → **Diagnosics** → **Diagnosics**
 → <Parameter status> tab

[Setting screen]

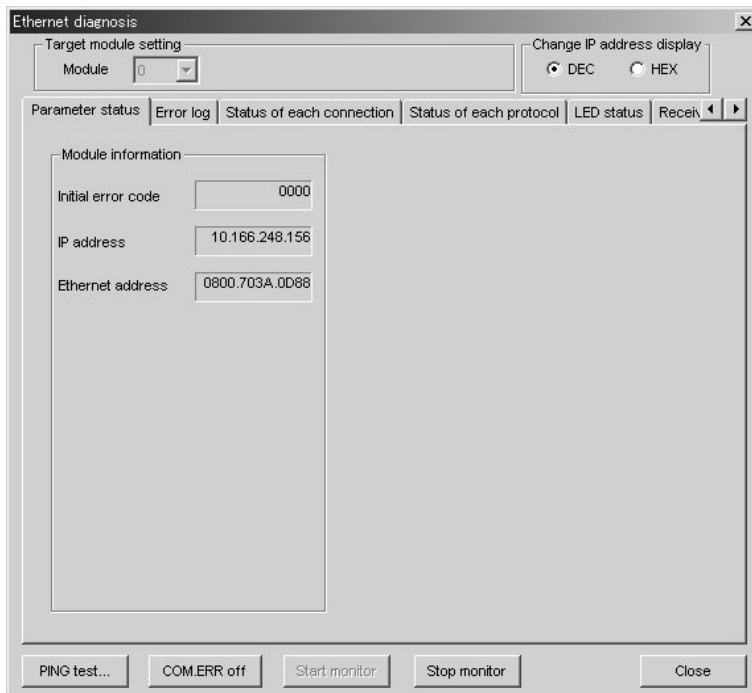

Item name	Description of setting
Initial error code	Displays the initial error code.
IP address	Displays the station IP address.
Ethernet address	Displays the station Ethernet address.

6.3 Error Log

[Purpose of setting]

Monitors the error log area.

[Operating procedure]

Select [Ethernet settings] of FX Configurator-EN → **Diagnosics** → **Diagnosics**
 → <Error log > tab

[Setting screen]

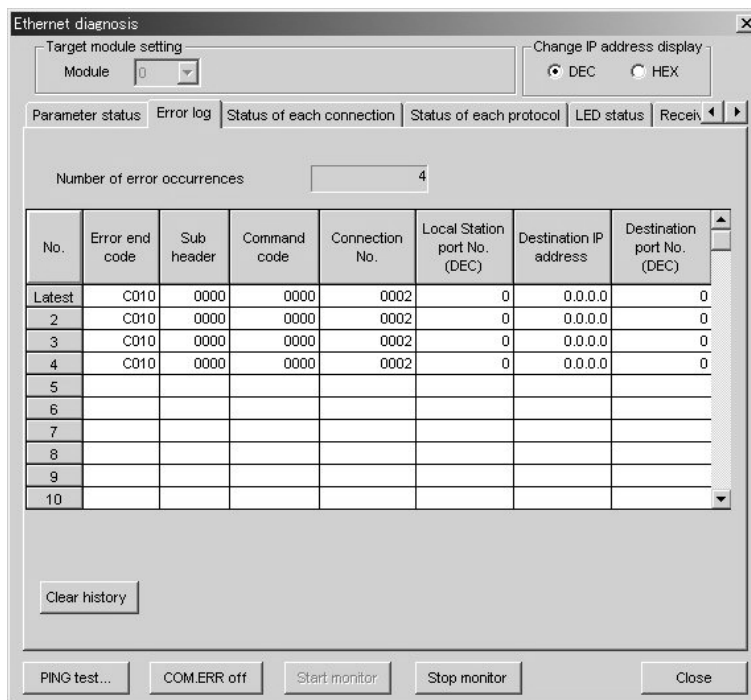

Item name	Description of setting
Number of error occurrences	Displays the number of error occurrences
Error end code	Displays the error/termination code.
Sub header	Displays the sub header.
Command code	Displays the command code.
Connection No.	Displays the connection number.
Local Station port No.	Displays the station port number.
Destination IP address	Displays the IP address on the other end of communication.
Destination port No.	Displays the port number on the other end of communication.
Clear history button	Clears the error history.

6.4 Status of Each Connection

[Purpose of setting]

Monitors the status of each connection.

[Operating procedure]

Select [Ethernet settings] of FX Configurator-EN → **Diagnosics** → **Diagnosics**
 → <Status of each connection> tab

[Setting screen]

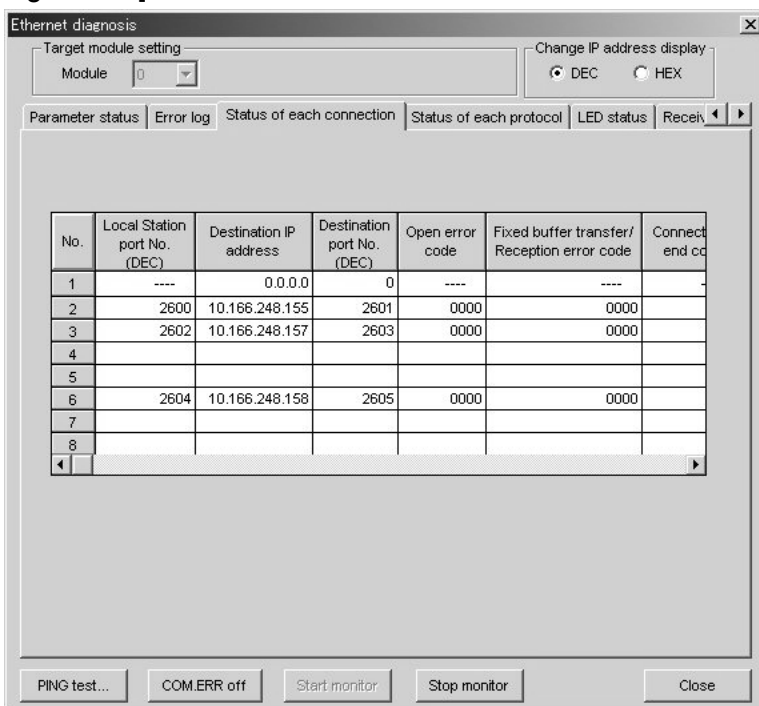

Item name	Description of setting
Local Station port No.	Displays the own station port number.
Destination IP address	Displays the IP address on the other end of communication.
Destination port No.	Displays the port number on the other end of communication.
Open error code	Displays the open error code.
Fixed buffer transfer/ reception error code	Displays the fixed buffer send error code.
Connection end code	Displays the connection termination code.
Protocol	Displays the UDP or TCP.
Open system	Displays Active, Unpassive, Fullpassive or MELSOFT.
Pairing open	Displays whether pairing is made or not.
Existence confirmation	Displays whether check is made or not.

6.5 Status of Each Protocol

[Purpose of setting]

Monitors the status of each protocol.

[Operating procedure]

Select [Ethernet settings] of FX Configurator-EN → **Diagnostics** → **Diagnostics**
 → <Status of each protocol> tab

[Setting screen]

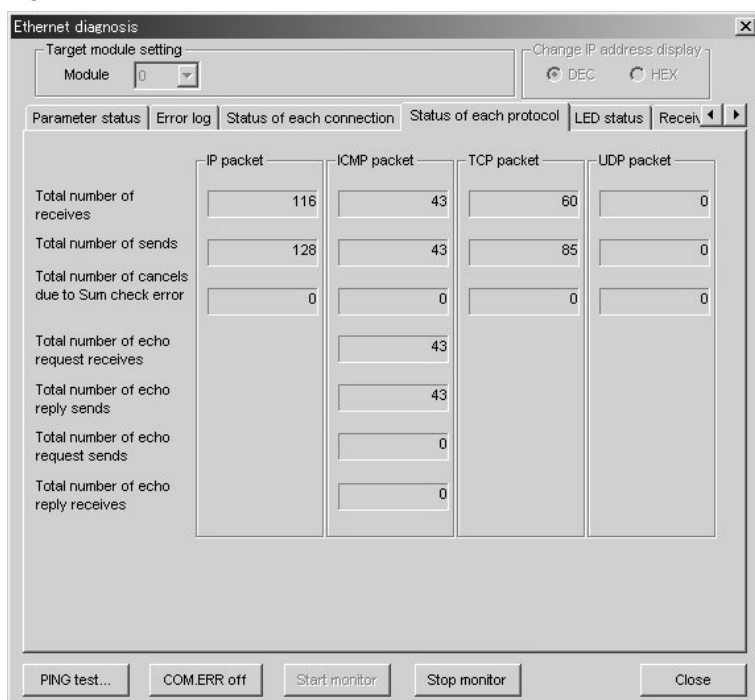

Item name	Description of setting
IP packet	Total number of receives : Displays the total number of received IP packets. Total number of sends : Displays the total number of sent IP packets. Total number of cancels due to Sum check error : Displays the number of times the received IP packets were discarded due to a Sum check error.
ICMP packet	Total number of receives : Displays the total number of received ICMP packets. Total number of sends : Displays the total number of sent ICMP packets. Total number of cancels due to Sum check error : Displays the number of times the received ICMP packets were discarded due to a sum check error. Total number of echo requests received : Displays the total number of received ICMP's echo requests. Total number of echo reply sends : Displays the total number of sent ICMP's echo replies. Total number of echo request sends : Displays the total number of sent ICMP's echo requests. Total number of echo reply receives : Displays the total number of received ICMP's echo replies.

Item name	Description of setting	
TCP packet	Total number of receives	: Displays the total number of received TCP packets.
	Total number of sends	: Displays the total number of sent TCP packets.
	Total number of cancels due to Sum check error	: Displays the number of times when the received TCP packets were discarded due to a sum check error.
UDP packet	Total number of receives	: Displays the total number of received UDP packets.
	Total number of sends	: Displays the total number of sent UDP packets.
	Total number of cancels due to Sum check error	: Displays the number of times when the received UDP packets were discarded due to a sum check error.

6.6 LED Status

[Purpose of setting]

Monitors the LED light-up status on the Ethernet module front.

[Operating procedure]

Select [Ethernet settings] of FX Configurator-EN → **Diagnosics** → **Diagnosics**
 → <LED status> tab

[Setting screen]

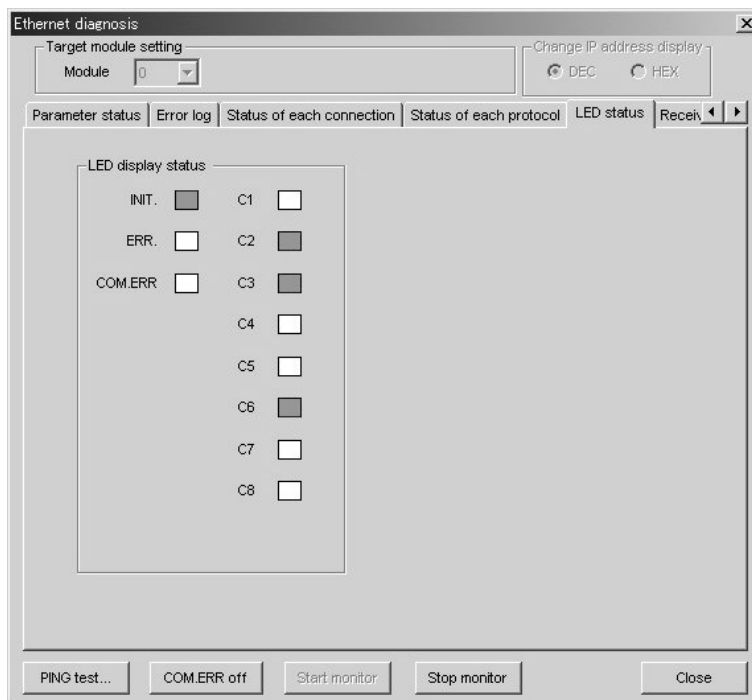

Item name	Description of setting
LED display status	Displays the statuses of the INIT., ERR., COM. ERR and connection Nos. 1 to 8 LEDs.

6.7 Received E-mail Information

[Purpose of setting]

Monitors the received e-mail information.

[Operating procedure]

Select [Ethernet settings] of FX Configurator-EN → **Diagnosics** → **Diagnosics**
 → <Received e-mail information> tab

[Setting screen]

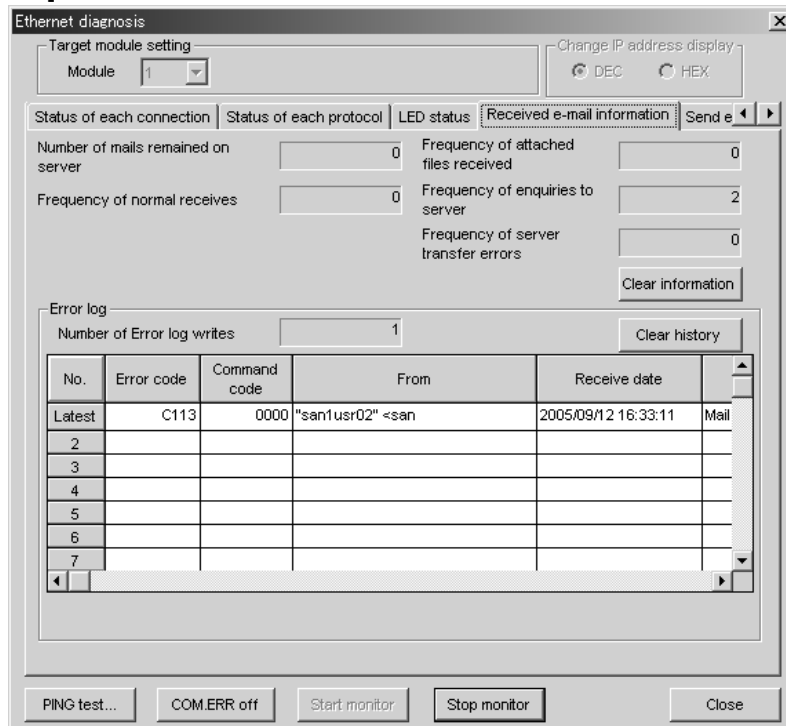

Item name	Description of setting
Number of mails remained on server	Displays the number of mails remaining on the server.
Frequency of normal receives	Displays the number of times mails were received normally.
Frequency of attached files received	Displays the number of times attached files were received.
Frequency of enquiries to server	Displays the number of server enquiries.
Frequency of server transfer errors	Displays the number of server communication errors.

Item name	Description of setting
Error log	Displays the number of times the error log was written to. The error log items are indicated below. <ul style="list-style-type: none">- Error code- Command code- Sender- Receiving date/hour- Subject
<input type="button" value="Clear information"/> button	Clears the count to zero.
<input type="button" value="Clear history"/> button	Clears the error log write count to zero and clears all error history.

6.8 Send E-mail Information

[Purpose of setting]

Monitors the send e-mail information.

[Operating procedure]

Select [Ethernet settings] of FX Configurator-EN → **Diagnosics** → **Diagnosics**
 <Send e-mail information> tab

[Setting screen]

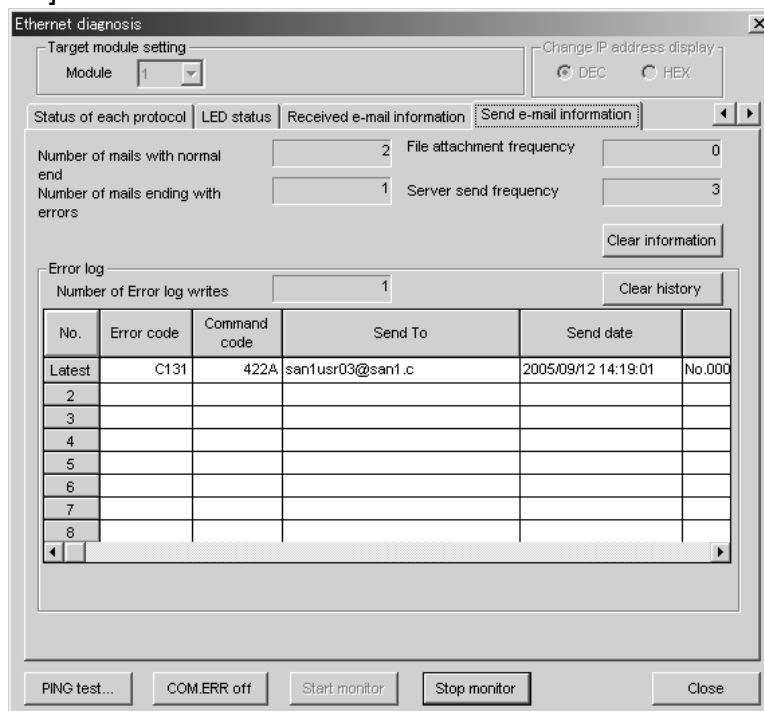

Item name	Description of setting
Number of mails with normal end	Displays the number of mails that were completed normally.
Number of mails ending with errors	Displays the number of mails that were completed abnormally.
File attachment frequency	Displays the number of times attached files were sent.
Server send frequency	Displays the number of server send times.
Error log	Displays the number of times the error log was written to. The error log items are indicated below. <ul style="list-style-type: none"> - Error code - Command code - Send destination - Sending date/hour - Subject
Clear information button	Clears the count to zero.
Clear history button	Clears the error log write count to zero and clears all error history.

6.9 PING Test

[Purpose of setting]

This test checks the Presence of the Ethernet module after it has completed initial processing on the Ethernet line or the existence of the specified IP address.

A PING test can be conducted either via an Ethernet or in direct connection with the PLC. The following can be checked by performing the PING test for the Ethernet module:

- Whether a line has been properly connected to the test target Ethernet module
- Whether the parameters for the Ethernet module have been correctly set
- Whether the initial processing for the Ethernet module has been completed normally

point

The PING test can be performed for an Ethernet module in the same Ethernet as the local station (same sub-net address.)

[Operating Procedure]

1) Executing the PING test via Ethernet

The example below explains how to execute the PING test for an Ethernet module in the same Ethernet by using FX Configurator-EN.

Settings in FX Configurator-EN are explained on the following pages.

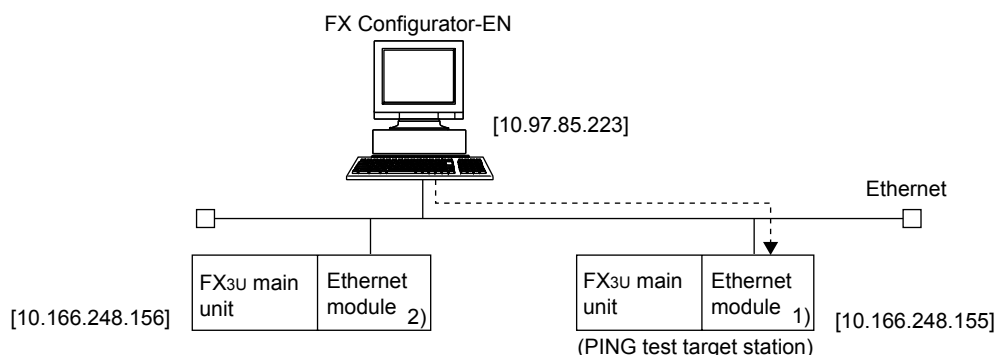

a) Setting the PING test target station

1. Set the following Ethernet module parameters for the PING test target station through FX Configurator-EN.

Use default values for setting items other than the ones listed below.

Setting screen	Setting item	Setting description	
		FX 1)	FX 2)
Operational setting	IP address	[10.166.248.155]	[10.166.248.156]
Open settings	Open system	-	MELSOFT connection*1

*1. For 2) Open settings of Ethernet module settings, specify one or more connections having "MELSOFT connection" as open settings without fail.

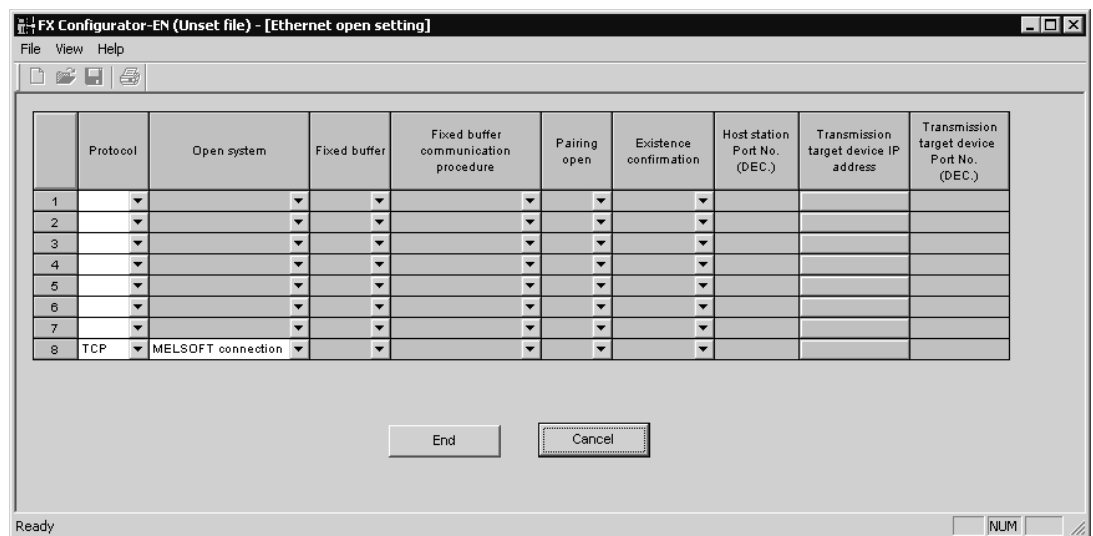

2. Write the parameters to the applicable station
3. Turning off the power of the Ethernet module and then turning it on again or re-initializing the processing will complete the initial processing.
(When the initial processing is completed normally, the [INIT.] LED of the Ethernet module lights up.)

b) FX Configurator-EN connection destination (connecting to FX 2)

Select [Ethernet setting]→ [Transfer setup] to display [PC side I/F setting] screen.

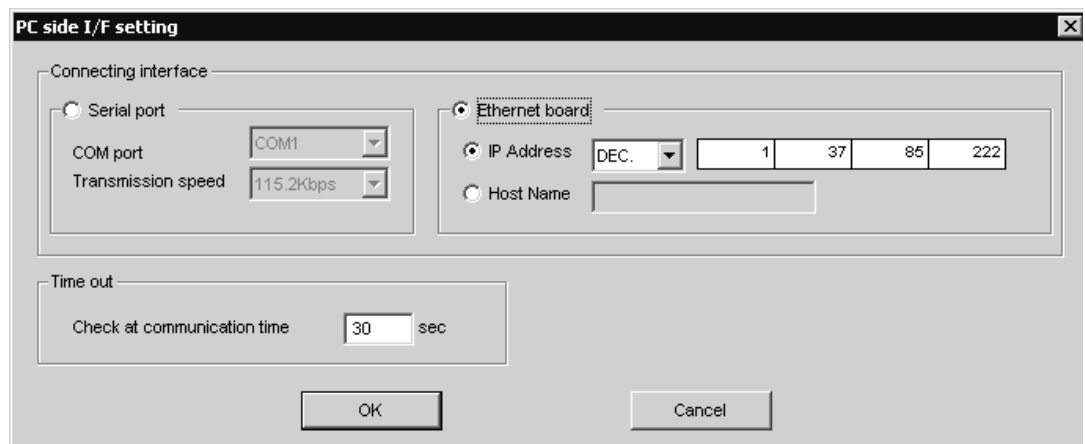

c) Executing the PING test through FX Configurator-EN

1. Select the PING test on the Ethernet diagnostics screen.
Select [Ethernet settings]→[Diagnostics]→[PING test] to display [PING test] screen.
2. Perform the settings indicated below, then click the Execute button.
The execution results of the PING test are displayed.

(Example) The following shows the flow of the PING test when “4” is designated as the transmission count.

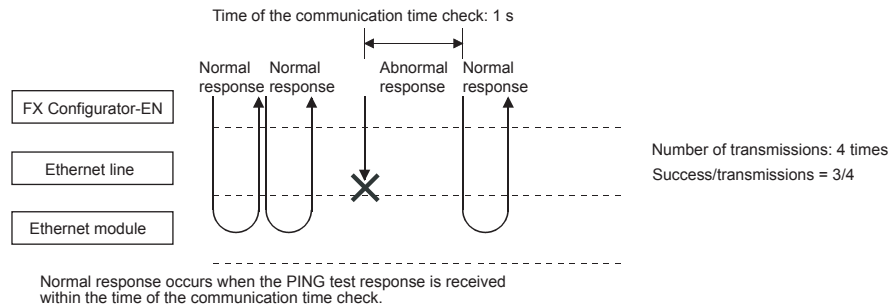

[PING Test Screen]

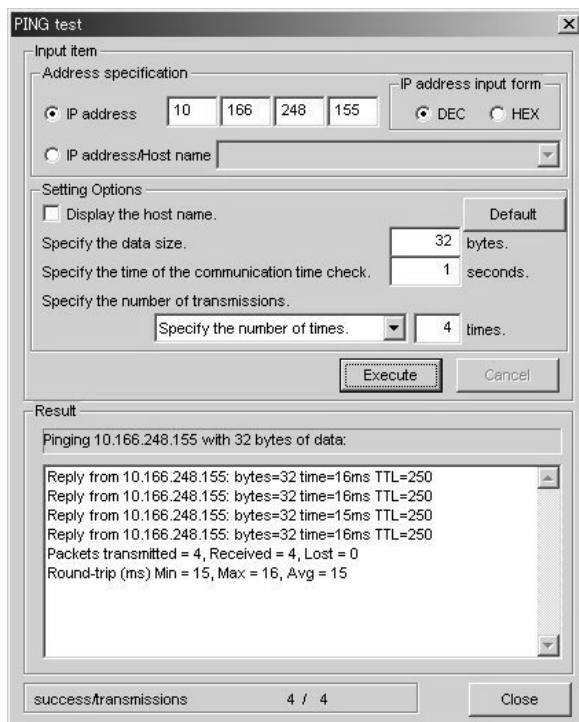
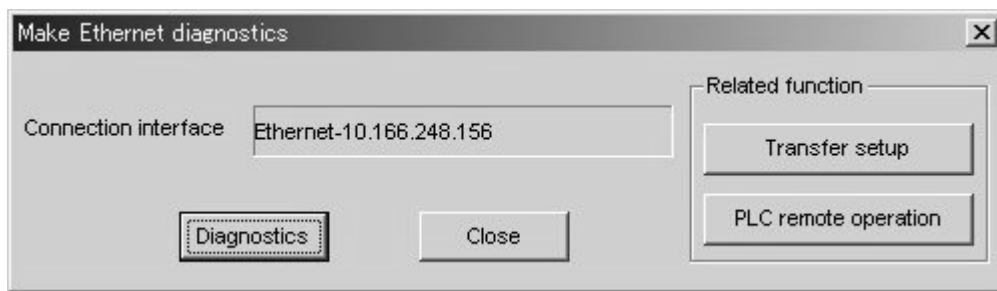

(Example of normal completion)

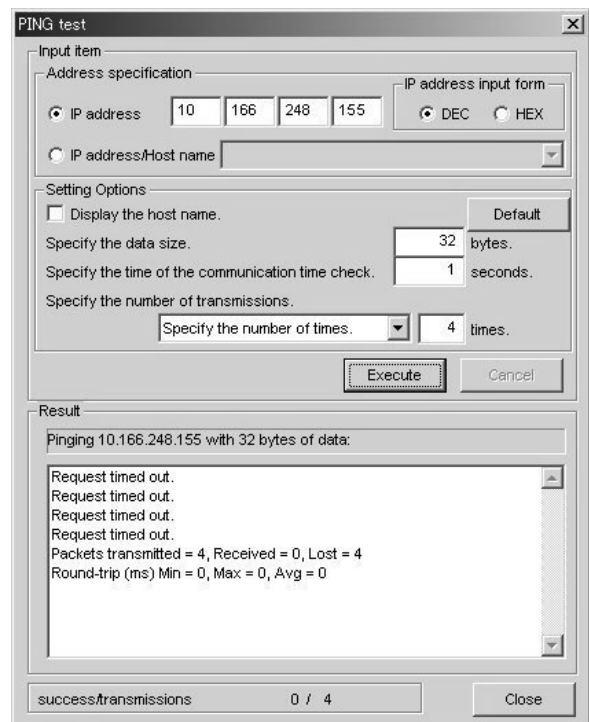

(Example of abnormal completion)

[Display Contents]

Item name	Setting item	Description of item setting	Setting range/options
Address specification	IP address	Specify the IP address for the PING test target station.	(Target station IP address)
	IP address input form	Select the input format for the IP address.	Decimal/hexadecimal
	Host name	Display the 10 latest inputs.	-
Option specification	Display the host name	Results are displayed using the host name corresponding to the IP address in the result display field.	-
	Specify the data size	Specify the size of the system data transmitted during the PING test. (Specify 1460 bytes or less for the Ethernet module.)	1 to 8192 bytes
	Specify the time of the communication time check	Specify the completion wait time for the PING test.	1 to 30 s
	Specify the number of transmissions	Specify the transmission count.	- Specify the number of times. - Execute until interruption.
Result		Display results of the PING test.	-
Success/transmissions		Display the total packet transmission count and the number of successes during the PING test.	-

(Address specification)

The PING test target station (external device subject to the PING test) is specified by the IP address or the host name.

1. Specification using the IP address

- Select the input format for the IP address (select: Decimal or hexadecimal)
- Specify the IP address of the external device according to the input format (decimal or hexadecimal).

2. Specification using the host name

Specify the host name of the external device set in the DNS server or the HOSTS file for the personal computer on which FX Configurator-EN is installed.

* The IP address can also be entered in the host name specification field.

(Option specification)

Set the details for the PING test. (No setting required if the default is used.)

1. Display the host name.

Select this to display the host name instead of the IP address for the PING test destination device in the result display field.

2. Specify the data size.

Specify the size of the system data to be transmitted during the PING test.
Input range: 1 to 8192 bytes (default: 32 bytes)

* The Ethernet module will return a response of 1460 bytes if the PING test is performed when a data size of 1460 bytes or greater for transmitting to the Ethernet module is specified.

3. Specify the time of the communication time check.

Specify the response wait time for the PING test.
Input range: 1 to 30 s (default: 1 s)

4. Specify the number of transmissions.

Specify the number of times the PING test is to be performed.

Selection item	Description of item	Remarks
Specify the number of times	The PING test is performed for the number of specified times.	Transmission count : 1 to 50 times (default : 4 times)
Execute untill interruption	The PING test is performed until the interrupt button is pressed.	-

(Result)

Results of the PING test are displayed.

<When the test is completed abnormally>

Check the following, then perform the PING test again.

- How the Ethernet module is mounted.
- Status of the connection to the Ethernet.
- Contents of the parameters written to the PLC.
- Operating status of the PLC (whether any errors have occurred).
- IP addresses set in FX Configurator-EN and the PING test target station.
- Whether the external device has been reset when the Ethernet module was changed.

(Success / transmissions)

The number of successes and the total packet transmission count from the PING test are displayed.

2) Executing the PING test via PLC

The example below explains how to execute the PING test for another Ethernet module by using FX Configurator-EN (GX Developer) connected to the FX3U. Settings in FX Configurator-EN (GX Developer) are explained on the following pages.

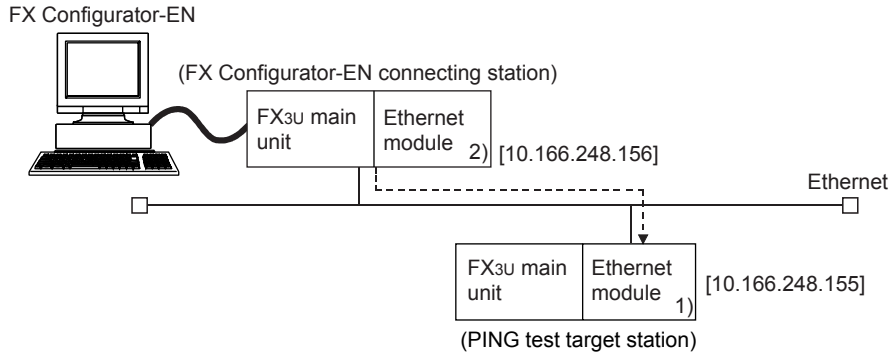

a) Settings on each FX3U-ENET station side

1. Set the following Ethernet module parameters for each FX3U-ENET using FX Configurator-EN.

Use default values for setting items other than the ones listed below.

Setting screen	Setting item	Setting description	
		FX 1)	FX 2)
Operational setting	IP address	[10. 166. 248. 155]	[10. 166. 248. 156]

2. Write the parameters to the applicable station.
The initial processing is completed when the PLC CPU restarts.
(When the initial processing is completed normally, the [INIT.] LED of the Ethernet module lights up.)
3. The initial processing is completed when the PLC CPU restarts.
(When the initial processing is completed normally, the [INIT.] LED of the Ethernet module lights up.)

b) Executing the PING test through FX Configurator-EN

1. Select the PING test on the Ethernet diagnostics screen.

Select [Ethernet settings]→[Diagnostics]→[PING test] to display [PING test] screen.

2. Perform the settings indicated below, then click the Execute button.

The execution results of the PING test are displayed.

(Example) The following shows the flow of the PING test when "4" is designated as the transmission count.

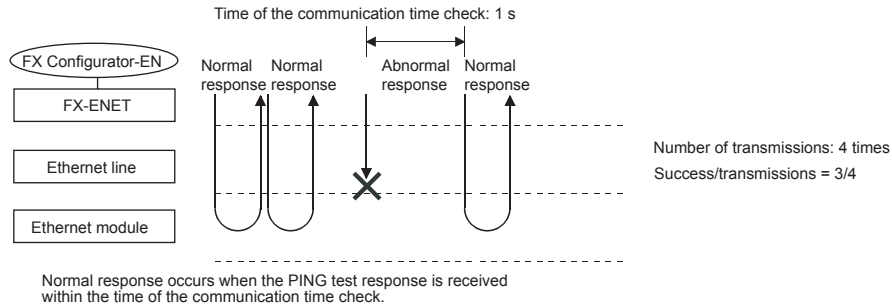

[PING test screen (via FX3U)]

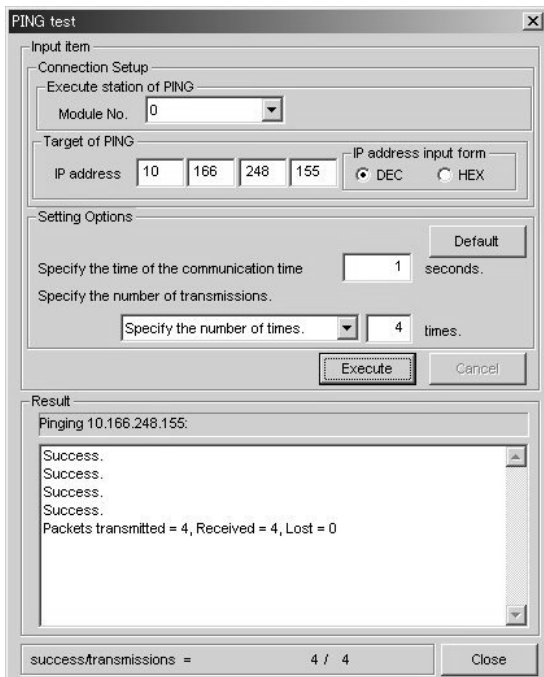
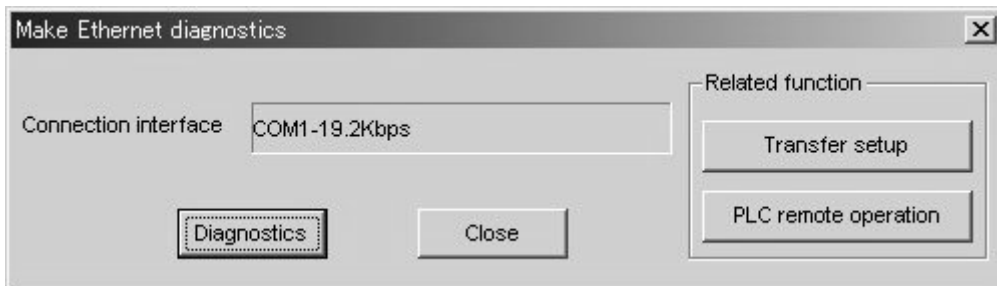

(Example of normal completion)

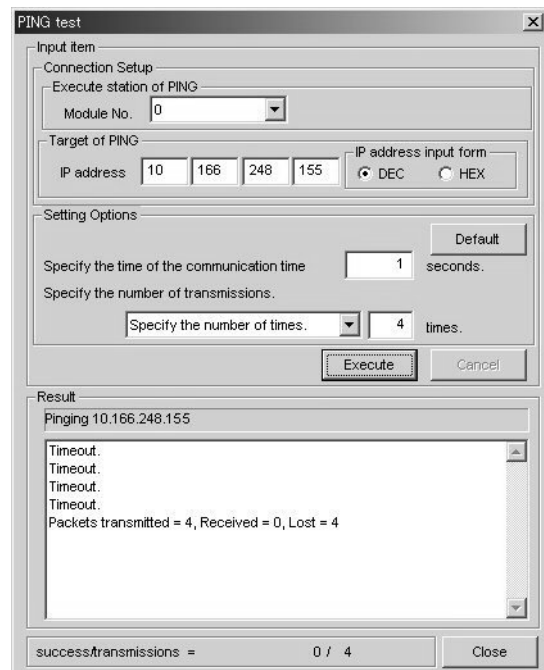

(Example of abnormal completion)

[Display contents]

Item name		Description of item setting	Setting range/option
Execute station of PING	Module No.	Specify the Ethernet module to execute the PING.	0 to 7
Target of PING	IP address	Specify the IP address of the PING test target station.	00000001 _H to FFFFFFFE _H
	IP address input form	Select the input format of the IP address.	Decimal/hexadecimal
Option specification	Specify the time of the communication time	Specify the response wait time for the PING test.	1 to 30 s
	Specify the number of transmissions	Specify the transmission count.	- Specify the number of times. - Execute until interruption.
Result		Display the result of the PING test.	-
success/transmissions		Display the total packet transmission count and its success count during the PING test execution.	-

(Connection Setup)

1. Station where PING is executed.

Specify the module No. of the Ethernet module to execute the PING test.

2. Target of PING

Specify the IP address of the PING test target station (the External device subject to the PING test).

- Select the input format of the IP address (select decimal or hexadecimal).
- Specify the IP address of the PING test target station according to the input format (decimal or hexadecimal).

(Option specification, result, success/transmissions)

The information displayed is the same as that displayed when performing a PING test via the Ethernet. Refer to (2) in this section.

7. Appendix

7.1 Printing parameters

7.1.1 Printing method

Print parameters set in FX Configurator-EN using a printer.

Any of the following methods may be used to print.

- "File" of FX Configurator-EN → "Print"
- Click  of FX Configurator-EN.

The following operation is available to display the printing image.

"File" of FX Configurator-EN → "Print" → Print preview

7.1.2 Printing example

Shown below is a printing example.

- Ethernet setting, operation setting, initial setting

Ethernet Setting				
Module No. 0				
Operational settings exist				
Initial settings exist				
Open settings exist				
Router relay parameter exist				
E-mail settings exist				
Ethernet operation setting				
Module No. 0				
1	Communication data code	Bin.code Transmit.		
2	Initial timing	No OPEN wait(No.Trans. at STOP)		
3	IP address	192.168. 1.254 (C0.A8.01.FE)		
4	Send frame	Ethernet(V2.0)		
5	TCP Ext. conf. setting	Use the Ping		
Ethernet initial setting				
Module No. 0				
1	Timer setting	Set value	Default	In units
	TCP ULP timer	43	60	*500ms
	TCP zero window timer	43	20	*500ms
	TCP resend timer	43	20	*500ms
	TCP end timer	43	40	*500ms
	IP assembly timer	11	10	*500ms
	Response monitoring timer	43	60	*500ms
	Dsti.Ext.Conf.start intval.	-----	1200	*500ms
	Dsti.Ext.Conf.intval.Timer	-----	20	*500ms
	Dsti.Ext.Conf.Resends Timer	-----	3	Times
2	DNS setting	IP address		
	IP address of DNS server 1	192. 0. 1.254 (C0.00.01.FE)		
	IP address of DNS server 2	192. 2. 2.254 (C0.02.02.FE)		
	IP address of DNS server 3	192. 6. 3.254 (C0.06.03.FE)		
	IP address of DNS server 4	192. 8. 4.254 (C0.08.04.FE)		

• Open setting, router relaying parameter setting

Ethernet open setting Module No. 0									
Connection No.	Protocol	Open system	Fixed buffer	Fixed buffer Communication procedure	Pairing open	Existence check	Host station Port No. (DEC.)	Transmission target device IP address	Target Port No. (DEC.)
1	TCP	Active	Send	Proc.Exi	No Fairs	No confirm	1025	111.222.222.222 (6F.DE.DE.LE)	1025
2	-----	-----	-----	-----	-----	-----	-----	-----	-----
3	-----	-----	-----	-----	-----	-----	-----	-----	-----
4	-----	-----	-----	-----	-----	-----	-----	-----	-----
5	-----	-----	-----	-----	-----	-----	-----	-----	-----
6	-----	-----	-----	-----	-----	-----	-----	-----	-----
7	-----	-----	-----	-----	-----	-----	-----	-----	-----
8	-----	-----	-----	-----	-----	-----	-----	-----	-----

Ethernet router relay parameter Module No. 0		
1	Router relay function	Not used
2	Sub-net mask pattern	255.255.255. 0 (FF.FF.FF.00)
3	Router IP address	104.105.106.107 (68.69.6A.6B)

• E-mail setting

Ethernet e-mail setting Module No. 0		
1	Information of ethernet module	
	Password	*****
	Mail Address	mail@mail.com
	PLC inquiry interval	No Setting
2	Mail server name	
	SMTP Srv.Name	server@mail.com
	POP Srv.Name	server@mail.com
3	Send mail address	
	1	mail@mail.com
	2	No Setting
	3	No Setting
	4	No Setting
	5	No Setting
	6	No Setting
	7	No Setting
	8	No Setting
	9	No Setting
	10	No Setting

7.2 Connecting the Ethernet module compatible with MX Component

This section describes the connection of the Ethernet module compatible with MX component.

For MX Component functions other than the ones described in this section, refer to the "MC Component operating manual" and the "MX Component programming manual."

Caution

When MX Component is installed after FX Configurator-EN, re-install the FX Configurator-EN.

7.2.1 System Configuration

1) Ethernet modules and their compatible PLCs.

Ethernet module	Compatible PLC	Protocol	Port No.
FX3U-ENET	<ul style="list-style-type: none"> FX3U FX3UC (FX2NC-CNV-IF or FX3UC-1PS-5V is necessary.) 	TCP	No Setting
FX2NC-ENET-ADP	<ul style="list-style-type: none"> FX1S, FX1N, FX2N (Expansion board is necessary.) FX1NC, FX2NC 	TCP	1024 to 32767

2) Connection of FX3U, FX3UC PLC

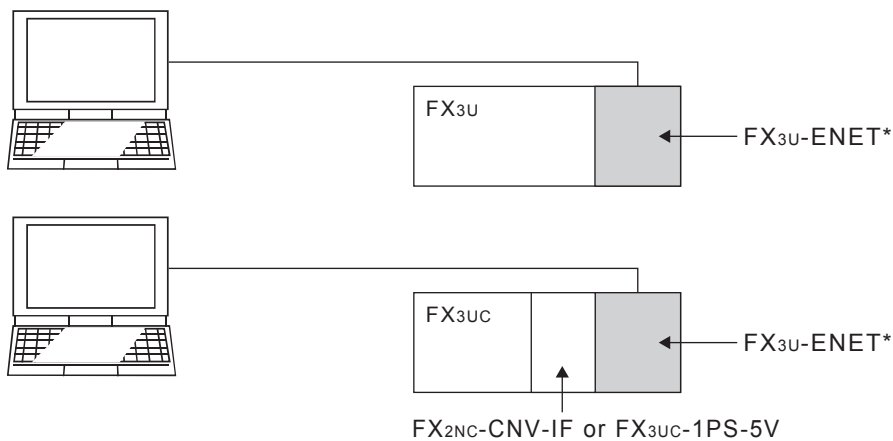

* Select "MELSOFT connection" in the FX3U-ENET open system.

3) Connection of FX1S, FX1N, FX2N, FX1NC or FX2NC PLC

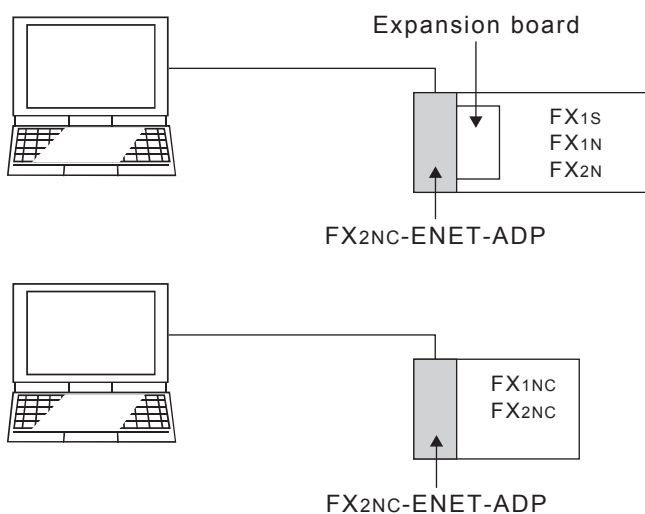

7.2.2 Communication setting wizard for Ethernet communication

1) I/F setting on PC side

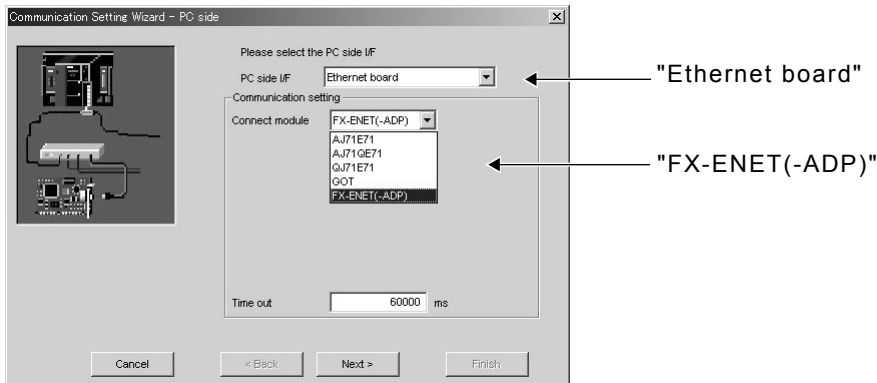

2) I/F setting on PLC side

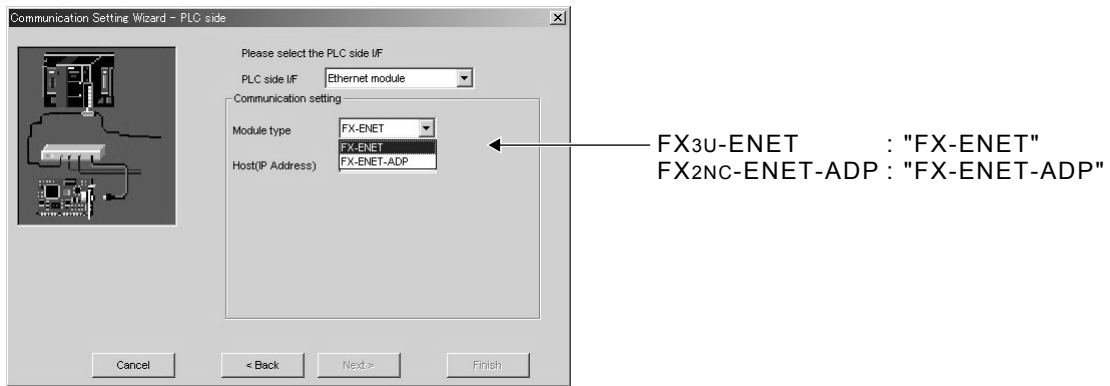

3) When selecting "FX-ENET"

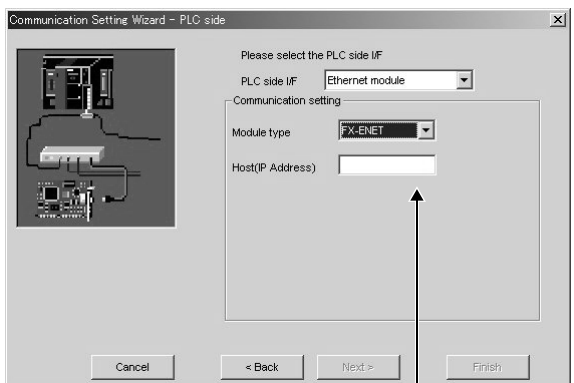

Host name (IP address)

4) When selecting "FX-ENET-ADP"

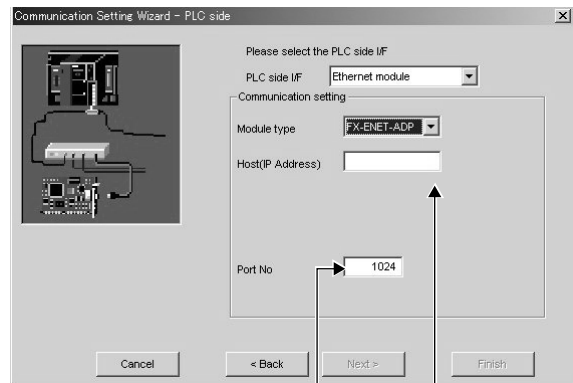

Host name (IP address)
Port number : 1024-32767

7.2.3 ATC control: ActFxENETTCP and ActMLFxENETTCP controls

The following table indicates the ActFxENETTCP, ActMLFxENETTCP and ActMLFxENETTCP control properties along with their default values.

1) Configuration

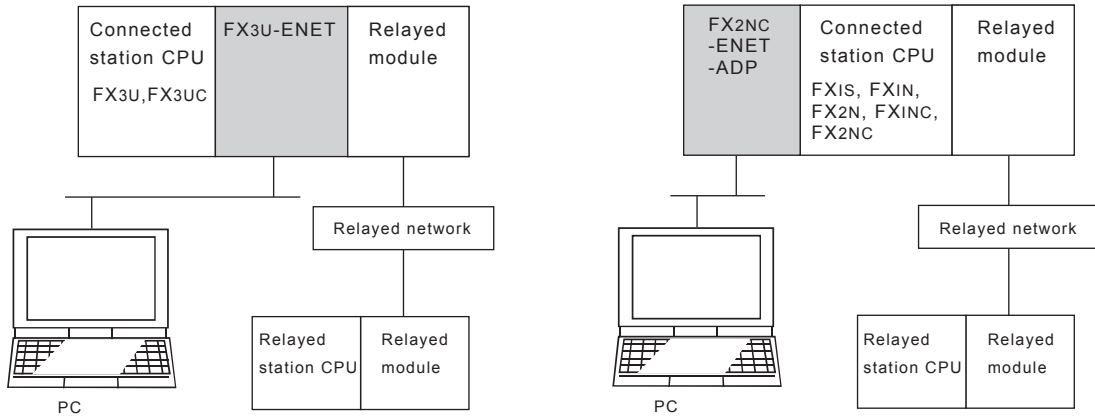

2) Property patterns

Connected Station CPU		Relayed Network	Relayed Station CPU				
FX3U FX3UC	FX1S FX1N FX2N FX2NC FX1NC		QCPU (Q mode)	QCPU (A mode)	QnA CPU	A CPU *1	FX CPU
(1)	(2)	MELSECNET/H					
		MELSECNET/10	X	X	X	X	X
		MELSECNET/(II)					
		Ethernet	X	X	X	X	X
		Computer link	X	X	X	X	X
		CC-Link	X	X	X	X	X

○ : Accessible (Property pattern within circle)

✕ : Inaccessible

*1 : Including motion controller CPU

3) Property list

Property	Default Value	Property Patterns	
		(1)	(2)
ActCpuType	CPU_FX2N(C) (0x205)	CPU type corresponding to target station FX3U(C)	CPU type corresponding to target station FX1S, FX1N(C), FX2N(C)
ActDestinationPortNumber	1280 (0x500)	Port number of connected station side module	Port number of connected station side module 1024-32767
ActHostAddress	1.1.1.1	Host name or IP address of connected station side module	
ActTimeOut	30000	Any value specified by user in units of ms	

Revised History

Date	Revision	Description
9/2005	A	First Edition
3/2008	B	<ul style="list-style-type: none">• Microsoft® Windows Vista® added to the applicable Operating System of the personal computer.• FX3UC Series PLC was added.• Caution on using MX Component was added.• Manual (Model and Model code) was added.• Clerical error correction

OPERATION MANUAL

FX Configurator-EN



HEAD OFFICE: TOKYO BUILDING, 2-7-3 MARUNOUCHI, CHIYODA-KU, TOKYO 100-8310, JAPAN
HIMEJI WORKS: 840, CHIYODA CHO, HIMEJI, JAPAN

MODEL	SW-FXENET-O-E
MODEL CODE	09R919