

MITSUBISHI

Mitsubishi Safety Programmable Controller

MELSEC **QS** series

Safety Relay Module

User's Manual



● SAFETY PRECAUTIONS ●

(Always read these instructions before using this equipment.)

Before using the product, please read this manual, the relevant manuals introduced in this manual, standard programmable controller manuals, and the safety standards carefully and pay full attention to safety to handle the product correctly.

In this manual, the safety instructions are ranked as "DANGER" and "CAUTION".



Indicates that incorrect handling may cause hazardous conditions, resulting in death or severe injury.



Indicates that incorrect handling may cause hazardous conditions, resulting in medium or slight personal injury or physical damage.

Note that the  CAUTION level may lead to a serious consequence according to the circumstances. Always follow the instructions of both levels because they are important to personal safety.

Please save this manual to make it accessible when required and always forward it to the end user.

[Design Precautions]

DANGER

- A safety relay module turns OFF all outputs by safety input or a failure of external power supply. Create an external circuit to securely stop the power of hazard by turning OFF the outputs. Incorrect configuration may result in an accident.
- When overcurrent due to such as load short-circuit or load current exceeding the rating flows for a long time, it may cause smoke or fire. To prevent this, create external safety circuit such as a fuse.
- Create short-circuit current protection for a safety relay and a protection circuit such as a fuse and breaker, outside a safety relay module.
- To inhibit a restart without manual operation after safety function of the safety relay module was performed and outputs were turned OFF, create reset start-up circuit using such as a reset switch outside the safety relay module.

[Design Precautions]



CAUTION

- The safety category is evaluated by the whole equipment. Make sure that the whole equipment meets the requirements before use.
- Use the programmable controller in an environment that meets the general specifications contained in this manual.
Using this programmable controller in an environment outside the range of the general specifications could result in electric shock, fire, erroneous operation, and damage to or deterioration of the product.
- The life of safety relay used for the safety relay module depends on the open-close condition and load. Be sure to operate the equipment by use conditions to make sure that the number of allowable times that the relay opens/closes.
- Do not install the wiring of external devices or communication cables together with the main circuit or power lines, or bring them close to each other. Keep a distance of 100mm (3.94 inch) or more between them.
Not doing so could result in noise that would cause erroneous operation.

[Installation Precautions]



DANGER

- Do not use the product in flammable gas atmosphere or explosive gas atmosphere.
Doing so may result in fire or explosion due to such as an arc caused by opening/closing the relays.



CAUTION

- For Q series safety relay module, while pressing the module mounting lever located at the bottom of a module, fully insert the module fixing projection into the fixing hole on the base unit. Then, mount the module with the fixing hole as a supporting point.
Incorrect loading of the module can cause a malfunction, failure or drop.
When using the programmable controller in the environment of much vibration, tighten the module with a screw.
Tighten the screw in the specified torque range.
Undertightening can cause a drop, short circuit or malfunction.
Overtightening can cause a drop, short circuit or malfunction due to damage to the screw or module.
- Make sure to fix CC-Link safety relay module and extension safety relay module with a DIN rail fixing bracket.

[Installation Precautions]

CAUTION

- Be sure to shut off all phases of the external supply power used by the system before mounting/removing a module.
Not doing so may result in damage to the product.
- When mounting a module, make room for 5cm (1.97 inch) or more at above and below of the module for ventilation.
When powering ON a contact at 3A or more consecutively, make room for 5mm (0.20 inch) or more at the sides of the contact for ventilation.
- Do not directly touch the module's conductive parts or electronic components.
Doing so may cause malfunctions or a failure.
- Securely connect connectors for each cable to the applied parts.
Not doing so may cause a malfunction due to poor connection.

[Wiring Precautions]

DANGER

- Be sure to shut off all phases of the external supply power used by the system before wiring.
Not completely turning off all power could result in electric shock or damage to the product.
- When energizing or operating the module after installation or wiring, be sure to close the attached terminal cover.
Not doing so may result in electric shock.



CAUTION

- Ground the FG and LG terminals correctly.
Not doing so could result in electric shock or malfunctions.
- Wire the module correctly after confirming the rated voltage and terminal layout.
Connecting a power supply of a different rated voltage or incorrect wiring may cause a fire or failure.
- Be sure there are no foreign substances such as sawdust or wiring debris inside the module.
Such debris could cause a fire, failure, or malfunctions.
- Tighten a terminal block mounting screw, terminal screw, and module mounting screw within the specified torque range.
If the terminal block mounting screw or terminal screw is too loose, it may cause a short circuit, fire, or malfunctions. If too tight, it may damage the screw and/or the module, resulting in a drop of the screw or module, a short circuit or malfunctions.
If the module mounting screw is too loose, it may cause a drop of the screw or module.
Over tightening the screw may cause a drop due to the damage of the screw or module.
- Be sure to fix the communication cables or power cables by ducts or clamps when connecting them to the module.
Failure to do so may cause damage of the module or cables due to a wobble, unintentional shifting, or accidental pull of the cables, or malfunctions due to poor contact of the cable.

[Wiring Precautions]

CAUTION

- When removing the connected communication cables or power cables, do not pull the cable with grasping the cable part.
Remove the cable connected to the terminal block after loosening the terminal block screws.
Pulling the cable connected to a module may result in malfunctions or damage of the module or cable.
- Use applicable solderless terminals and crimp them with a tool specified by maker.
Imperfect connections could result in short circuit, fires, or erroneous operation.
- A protective film is attached to the top of the Q series safety relay module to prevent foreign matter such as wire chips from entering the module during wiring.
Do not peel this label during wiring.
Before starting system operation, be sure to peel this label because of heat dissipation.
- Install our programmable controller in a control panel complying with the IP standard of 54 or more.
Wire the main power supply to the power supply module installed in a control panel through a distribution terminal block.
Furthermore, the wiring and replacement of a power supply module have to be performed by a maintenance worker who acquainted with shock protection.
For wiring method, refer to the QCPU User's Manual (Hardware Design, Maintenance and Inspection).
- Do not install the control lines together with the communication cables or bring them close to each other.
Doing so may cause a malfunction due to noise.

[Startup and Maintenance Precautions]

DANGER

- Do not touch the terminals while power is on.
Doing so could result in electric shock.
- Turn off all phases of the external supply power used in the system when cleaning the module or retightening the terminal block mounting screws, terminal screws, or module mounting screws.
Not doing so could result in electric shock.
Tighten a terminal block mounting screw and module mounting screw within the specified torque range.
If the terminal block mounting screw is too loose, it may cause a short-circuit, fire or malfunctions.
If too tight, it may damage the screw and/or the module, resulting in a drop of the screw or module, a short circuit or malfunctions.
If the module mounting screw is too loose, it may cause a drop of the screw or module.
Over tightening the screw may cause a drop due to the damage of the screw or module.

[Startup and Maintenance Precautions]



CAUTION

- Do not disassemble or remodel the module. Doing so could cause a failure, malfunctions, injury, or fire.
If the product is repaired or remodeled by other than the specified FA centers or us, the warranty is not covered.
- A electric fuse for overcurrent prevention is incorporated in the control circuit part of the safety relay module.
If the electric fuse operates, power OFF the module once, and power it ON again after resolving the failure.
- Restrict the mounting/removal of a module, base unit, and terminal block up to 50 times (IEC61131-2-compliant), after the first use of the product.
Failure to do so may cause the module to malfunction due to poor contact of connector.
- Since the module case is made of resin, do not drop or apply any strong impact to the module.
Doing so may damage the module.
- Completely turn off the externally supplied power used in the system before mounting or removing the module to/from the panel.
Not doing so may result in a failure or malfunctions of the module.
- Use any radio communication device such as a cellular phone or a PHS phone more than 25cm (9.85 inch) away in all directions of the programmable controller.
Not doing so can cause a malfunction.
- Before touching the module, always touch grounded metal, etc. to discharge static electricity from human body, etc.
Not doing so can cause the module to fail or malfunction.

[Disposal Precautions]



CAUTION

- When disposing of this product, treat it as industrial waste.

REVISIONS

* The manual number is given on the bottom left of the back cover.

Print date	*Manual number	Revision
Apr., 2008	SH(NA)-080746ENG-A	First edition
Jun., 2008	SH(NA)-080746ENG-B	Partial corrections COMPLIANCE WITH THE EMC AND LOW VOLTAGE DIRECTIVES, Section 5.1.1, 5.1.4, 5.2.1, 5.3.1, 6.1.2, 6.2.2, 6.3.2
Nov., 2008	SH(NA)-080746ENG-C	Partial corrections Section 3.1, 3.2.2, 3.4.1, 5.4.1, 5.4.7

Japanese Manual Version SH-080745-C

This manual confers no industrial property rights or any rights of any other kind, nor does it confer any licenses. Mitsubishi Electric Corporation cannot be held responsible for any problems involving industrial property rights which may occur as a result of using the contents noted in this manual.

INTRODUCTION

Thank you for choosing the Mitsubishi safety relay module.

Before using this product, please read this manual carefully to develop full familiarity with the functions and performance of the safety relay module to ensure correct use.

CONTENTS

SAFETY PRECAUTIONS	A - 1
REVISIONS	A - 7
INTRODUCTION	A - 8
CONTENTS	A - 8
ABOUT MANUALS	A - 11
COMPLIANCE WITH THE EMC AND LOW VOLTAGE DIRECTIVES	A - 11
GENERIC TERMS AND ABBREVIATIONS	A - 12
PACKING LIST	A - 12

CHAPTER1 OVERVIEW **1 - 1 to 1 - 4**

1.1 About Safety Relay Module	1 - 1
1.2 Features	1 - 2
1.3 Checking the Safety Relay Module Model	1 - 4

CHAPTER2 SYSTEM CONFIGURATION **2 - 1 to 2 - 3**

2.1 System Configuration	2 - 1
2.2 Applicable Systems	2 - 2

CHAPTER3 SPECIFICATIONS **3 - 1 to 3 - 15**

3.1 General Specifications	3 - 1
3.2 Q Series Safety Relay Module Specifications	3 - 2
3.2.1 QS90SR2SP-Q Q series safety relay module	3 - 2
3.2.2 QS90SR2SN-Q Q series safety relay module	3 - 4
3.3 CC-Link Safety Relay Module Specifications	3 - 6
3.3.1 QS90SR2SP-CC CC-Link safety relay module	3 - 6
3.3.2 QS90SR2SN-CC CC-Link safety relay module	3 - 8
3.4 Extension Safety Relay Module Specifications	3 - 10
3.4.1 QS90SR2SP-EX extension safety relay module	3 - 10
3.4.2 QS90SR2SN-EX extension safety relay module	3 - 12
3.5 I/O Signals	3 - 14
3.6 Cable Specifications	3 - 15

CHAPTER4 FUNCTIONS **4 - 1 to 4 - 5**

4.1 Dual Input Function	4 - 1
-------------------------------	-------

4.2	Start-up/off Check Function	4 - 2
4.3	Start-up Method Selection Function	4 - 3
4.4	Safety Output Function	4 - 3
4.5	Monitor Function	4 - 4
4.6	Partial Shutdown Function with Extension Module	4 - 5

CHAPTER5 SETTINGS AND PROCEDURES BEFORE OPERATION **5 - 1 to 5 - 30**

5.1	Q Series Safety Relay Module	5 - 1
5.1.1	Start-up procedures	5 - 1
5.1.2	Handling precautions	5 - 3
5.1.3	Part names and settings	5 - 4
5.1.4	Mounting/removal	5 - 5
5.2	CC-Link Safety Relay Module	5 - 6
5.2.1	Start-up procedures	5 - 6
5.2.2	Handling precautions	5 - 8
5.2.3	Part names and settings	5 - 9
5.2.4	Station number setting	5 - 11
5.2.5	Module installation direction	5 - 11
5.3	Extension Safety Relay Module	5 - 12
5.3.1	Start-up procedures	5 - 12
5.3.2	Handling precautions	5 - 14
5.3.3	Part names and settings	5 - 15
5.3.4	Module installation direction	5 - 17
5.4	Wiring	5 - 18
5.4.1	Precautions for safety devices and wiring	5 - 18
5.4.2	Spring clamp terminal block	5 - 25
5.4.3	Attaching/removing a terminal block	5 - 28
5.4.4	Precautions for handling CC-Link dedicated cable	5 - 28
5.4.5	Connecting with CC-Link dedicated cables	5 - 29
5.4.6	Precautions for wiring power supply	5 - 29
5.4.7	Connecting extension modules	5 - 30

CHAPTER6 TROUBLESHOOTING **6 - 1 to 6 - 7**

6.1	Q Series Safety Relay Module	6 - 2
6.1.1	Error check method with LED	6 - 2
6.1.2	Error check method with monitor signal	6 - 3
6.2	CC-Link Safety Relay Module	6 - 4
6.2.1	Error check method with LED	6 - 4
6.2.2	Error check method with monitor signal	6 - 5
6.3	Extension Safety Relay Module	6 - 6
6.3.1	Error check method with LED	6 - 6
6.3.2	Error check method with monitor signal	6 - 7

Appendix 1	External Dimensions	App - 1
Appendix 1.1	Q series safety relay module	App - 1
Appendix 1.2	CC-Link safety relay module	App - 2
Appendix 1.3	Extension safety relay module	App - 3

ABOUT MANUALS

The manuals related to this product are shown below.
Refer to the following table when ordering required manuals.

Related manuals

Manual name	Manual number (model code)
<p>QCPU User's Manual (Hardware Design, Maintenance and Inspection)</p> <p>This manual explains the specifications of the CPU module, power supply module, base unit, extension cable, and memory card.</p> <p>(Sold separately.)</p>	SH(NA)-080483ENG (13JR73)
<p>Control & Communication Link System Master/Local Module Type AJ61BT11/A1SJ61BT11 User's Manual</p> <p>This manual explains the system configuration, performance specifications, functions, handling, wiring, and troubleshooting of the AJ61BT11 and A1SJ61BT11.</p> <p>(Sold separately.)</p>	IB(NA)-66721 (13J872)
<p>Control & Communication Link System Master/Local Module type AJ61QBT11/A1SJ61QBT11 User's Manual</p> <p>This manual explains the system configuration, performance specifications, functions, handling, wiring, and troubleshooting of the AJ61QBT11 and A1SJ61QBT11.</p> <p>(Sold separately.)</p>	IB(NA)-66722 (13J873)
<p>CC-Link System Master/Local Module User's Manual QJ61BT11N</p> <p>This manual explains the system configuration, performance specifications, functions, handling, wiring, and troubleshooting of the QJ61BT11N.</p> <p>(Sold separately.)</p>	SH(NA)-080394E (13JR64)
<p>Type Q80BD-J61BT11N CC-Link System Master/Local Interface Board User's Manual (For SW1DNC-CCBD2-B)</p> <p>This manual explains the system configuration, performance specifications, functions, handling, wiring, and troubleshooting of the Q80BD-J61BT11N.</p> <p>(Sold separately.)</p>	SH-080527ENG (13JR77)

COMPLIANCE WITH THE EMC AND LOW VOLTAGE DIRECTIVES

(1) For programmable controller system

To configure a system meeting the requirements of the EMC and Low Voltage Directives when incorporating the Mitsubishi programmable controller (EMC and Low Voltage Directives compliant) into other machinery or equipment, refer to Chapter 9 "EMC AND LOW VOLTAGE DIRECTIVES" of the QCPU User's Manual (Hardware Design, Maintenance and Inspection).

The CE mark, indicating compliance with the EMC and Low Voltage Directives, is printed on the rating plate of the programmable controller.

(2) For the product

No additional measures are necessary for the compliance of this product with the EMC and Low Voltage Directives.

GENERIC TERMS AND ABBREVIATIONS

Unless otherwise specified, this manual uses the following generic terms and abbreviations to explain the safety relay module.

Generic term/abbreviation	Description
Q series safety relay module	Generic term for QS90SR2SP-Q and QS90SR2SN-Q
CC-Link safety relay module	Generic term for QS90SR2SP-CC and QS90SR2SN-CC
Extension safety relay module	Generic term for QS90SR2SP-EX and QS90SR2SN-EX
Safety relay module	Generic term for Q series safety relay module, CC-Link safety relay module, and extension safety relay module
Main module	Generic term for Q series safety relay module and CC-Link safety relay module
Extension module	Abbreviation for extension safety relay module

PACKING LIST

The following tables show the packing list of each product.

(3) Q series safety relay module

Product	Quantity
QS90SR2SP-Q safety relay module	1
QS90SR2SN-Q safety relay module	
Included manual	1

(4) CC-Link safety relay module

Product	Quantity
QS90SR2SP-CC safety relay module	1
QS90SR2SN-CC safety relay module	
Included manual	1

(5) Extension safety relay module

Product	Quantity
QS90SR2SP-EX safety relay module	1
QS90SR2SN-EX safety relay module	
Included manual	1

(6) Safety circuit part extension cable

Product	Quantity
QS90CBL-SE01	1
QS90CBL-SE15	1

CHAPTER1 OVERVIEW

This manual explains specifications, handling, and wiring methods of the safety relay module.

1.1 About Safety Relay Module

The safety relay module achieves basic safety functions for emergency stop only by wiring, without programming.

It is safety check type module whose output does not turn ON until all conditions of the safety input (normally closed contact), off check input (normally closed contact), and start-up switch (normally open contact) are met.

Using the module helps to reduce the man-hour taken for configuring a safety check system.

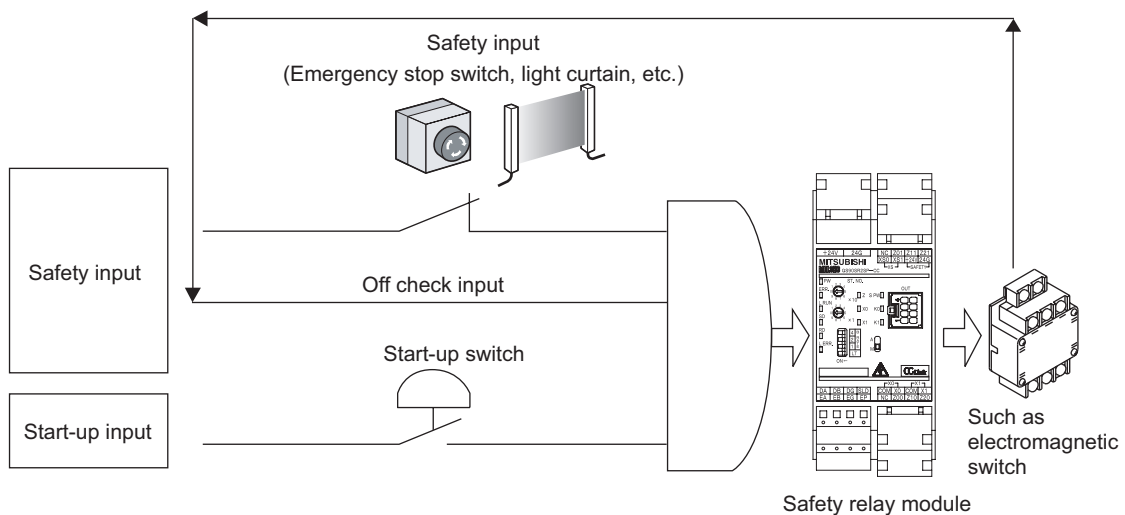

Figure 1.1 Safety relay module

1.2 Features

This section explains features of the safety relay module.

(1) Obtaining the highest level of safety approval

The safety relay module obtained the highest safety approval (Category 4 of EN954-1/ISO13849-1/performance level E) that the programmable controller can be gained (In some conditions, Category 3/performance level D can be gained).

A system ensuring higher safety can be configured.

(2) Category 3 and Category 4 compliant

A system complying with Category 3 or Category 4 of EN954-1 can be configured depending on safety input device to be connected and rated current.

Table 1.1 Conditions for complying with each category

Condition	Safety input device to be connected		Rated current	
	Contact-type input device	Type 4 light curtain	5.0A max.	3.6A max.
Dual input with positive commons (Input P type)	Category 3	Category 4	Category 3 or less	Category 3 or Category 4
Dual input with positive common and negative common (Input N type)	Category 4	Not connectable	Equivalent to Category 3	Category 4

(3) Monitoring safety control with the MELSEC-Q series is possible.

Mounting/connecting the safety relay module on/to existing MELSEC-Q series programmable controller allows monitoring operating status of the whole safety relay module and error status of the module.

(4) Small-scale safety control

The safety relay module is suited for small-scale safety control whose number of I/O points is around 10.

(a) Programming is unnecessary.

Safety circuits can be easily created only by wiring, without programming and settings.

Since an inspection on programming by safety certification organization is unnecessary, the man-hour taken for obtaining the safety approval can be omitted.

(b) Extension of safety circuit with extension module

By connecting extension safety relay modules, maximum 4 points of safety input and maximum 4 points of safety output can be controlled.

(c) Safety control can be performed by itself.

Since a communication circuit for Q series programmable controller and CC-Link is separated from a circuit for achieving the safety function, the safety relay module can perform safety control by itself, independent of a failure of the Q series programmable controller or CC-Link communication status.

(5) Fail safe

Fail safe can be achieved by inhibiting the safety relay module from starting when an error occurs in safety input, start-up input, and/or internal circuit of the safety relay module.

(6) Improvement of efficiency in wiring work

Using spring clamp terminal block allows to skip screw tightening work and to reduce wiring work significantly.

(7) Connector insertion check

Using terminal block cover for connector insertion check prevents poor connection. If the terminal block is not inserted securely, the terminal block cover does not close.

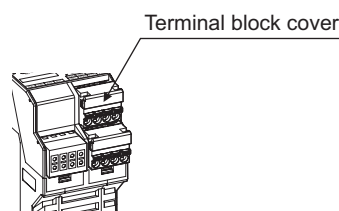

Figure 1.2 Terminal block cover

1.3 Checking the Safety Relay Module Model

This section explains how to check the safety relay module model.

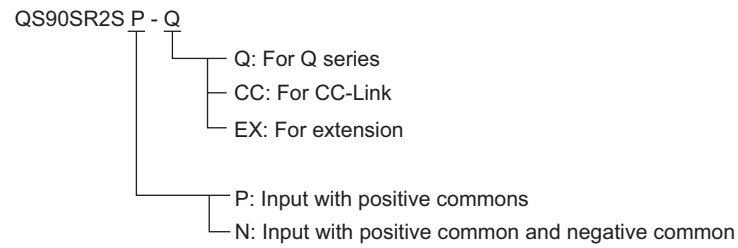

Figure 1.3 Checking the safety relay module model

CHAPTER2 SYSTEM CONFIGURATION

This chapter explains the system configuration, precautions for use, and system equipment of the safety relay module.

2.1 System Configuration

Figure 2.1 shows system configuration using the safety relay module.

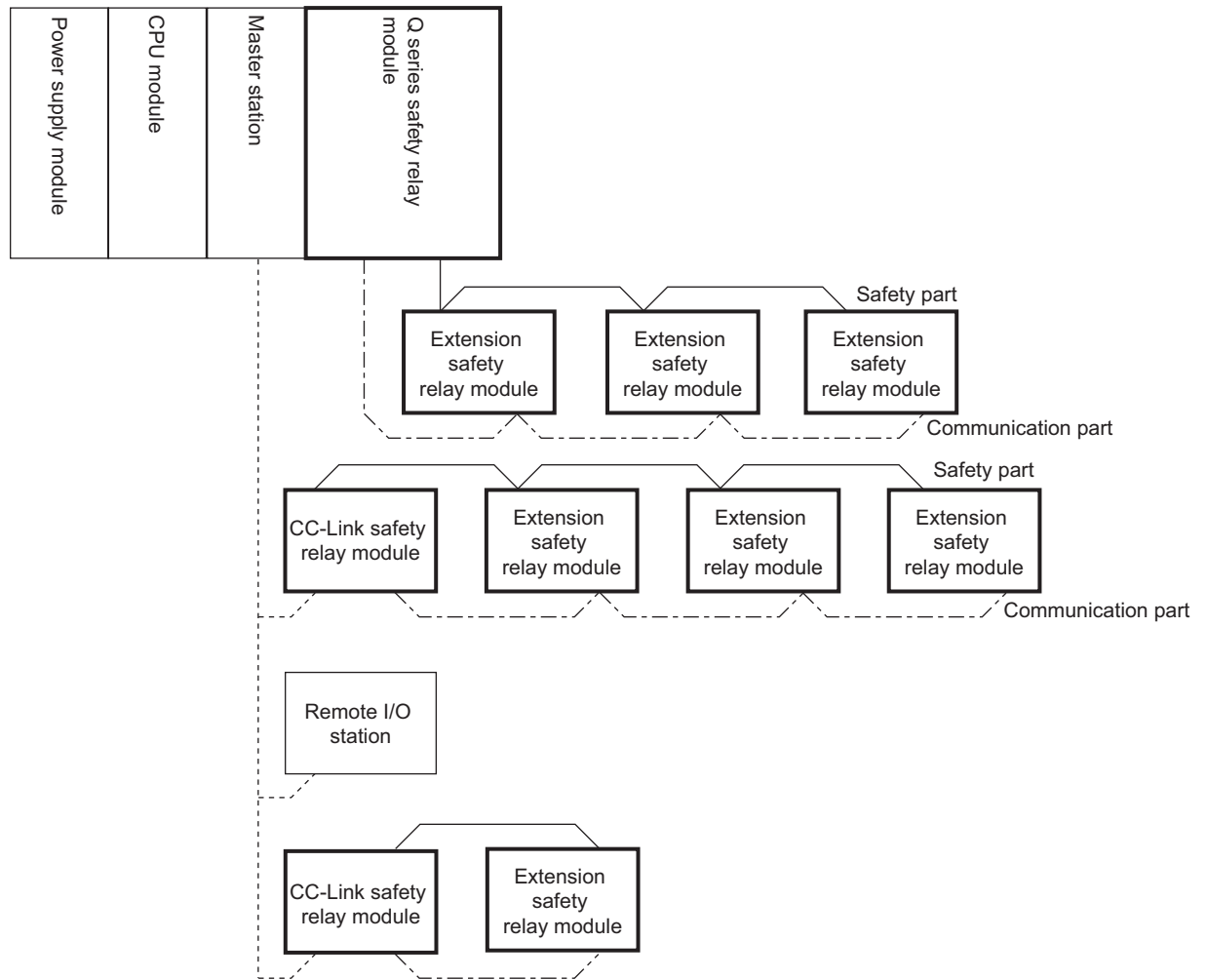

Figure 2.1 System configuration

2.2 Applicable Systems

(1) Mountable modules, the number of mountable modules, and mountable base units

(a) Q series safety relay module

1) When mounting to CPU module

The following table shows the mountable CPU modules, the number of mountable modules, and mountable base units of the Q series safety relay module.

Shortage of power capacity may occur depending on the combination with other mounted modules or the number of mounted modules.

When mounting modules, pay attention to the power capacity.

When shortage of power capacity occurs, review the combination of modules to be mounted.

Table 2.1 Applicable modules and the number of mountable modules

Mountable CPU module		Number of mountable modules ^{*1}	Mountable base unit ^{*2}		
CPU type	CPU model		Main base unit	Extension base unit	
Programmable controller CPU	Basic model QCPU	Q00JCPU	Up to 8		
		Q00CPU	Up to 12	○	○
		Q01CPU			
	High Performance model QCPU	Q02CPU	Up to 32	○	○
		Q02HCPU			
		Q06HCPU			
		Q12HCPU			
	Process CPU	Q12PHCPU	Up to 32	○	○
		Q25PHCPU			
	Universal model QCPU	Q02UCPU	Up to 18	○	○
		Q03UDCPU	Up to 32		
		Q04UDHCPU			
		Q06UDHCPU			
		Q13UDHCPU			
		Q26UDHCPU			
Redundant CPU	Q12PRHCPU	Up to 31	○	○	
	Q25PRHCPU				
C Controller module	Q06CCPU-V-H01	Up to 32	○	○	
	Q06CCPU-V				
	Q06CCPU-V-B				

○ : Mountable, × : Not mountable

* 1: Limited within the range of the number of I/O points for the CPU module.

* 2: Mountable on any I/O slots of the mountable base unit.

- 2) When mounting to remote I/O station in MELSECNET/H connection
 The following table shows the mountable network modules, the number of mountable modules, and mountable base units of the Q series safety relay module.

Shortage of power capacity may occur depending on the combination with other mounted modules or the number of mounted modules.

When mounting modules, pay attention to the power capacity.

When shortage of power capacity occurs, review the combination of modules to be mounted.

Table 2.2 Network modules and the number of mountable modules

Mountable network module	Number of mountable modules*1	Mountable base unit*2	
		Main base unit on remote I/O station	Extension base unit on remote I/O station
QJ72LP25-25	Up to 32	○	○
QJ72LP25G			
QJ72BR15			

○ : Mountable, × : Not mountable

* 1: Limited within the range of the number of I/O points for the network module.

* 2: Mountable on any I/O slots of the mountable base unit.

- (b) CC-Link safety relay module

The CC-Link safety relay module is used as remote I/O station.

For system configuration of the CC-Link system, refer to the Control & Communication Link System Master/Local Module User's Manual.

- (c) Extension safety relay module

Maximum three extension safety relay modules can be mounted to the Q series safety relay module or CC-Link safety relay module.

For extension method, refer to Section 5.3.

CHAPTER3 SPECIFICATIONS

3.1 General Specifications

Table 3.1 shows the general specifications of the safety relay module.

Table 3.1 General specifications

Item	Specifications					
Operating ambient temperature	0 to 55°C					
Storage ambient temperature	-25 to 75°C *3					
Operating ambient humidity	30 to 85%RH, non-condensing					
Storage ambient humidity	30 to 85%RH, non-condensing					
Vibration resistance	JIS B 3502, IEC 61131-2 compliant	Under intermittent vibration	Frequency	Acceleration	Amplitude	Sweep count 10 times each in X, Y, Z directions
			10 to 57Hz	-	0.075mm (0.003inch)	
		Under continuous vibration	57 to 150Hz	9.8m/s ²	-	-
			10 to 57Hz	-	0.035mm (0.001inch)	
Shock resistance	JIS B 3502, IEC 61131-2 compliant (147m/s ² , 3 times each in X, Y, Z directions)					
Operating ambience	No corrosive gases					
Operating altitude *4	2000m (6562ft.) or less					
Installation location	Inside of control panel of IP standard 54 or more					
Overvoltage category *1	III or less					
Pollution degree *2	2 or less					
Equipment category	Class I					

* 1: This indicates the section of power supply to which the equipment is assumed to be connected between the public electrical power distribution network and the machinery within the premises. Category III applies to devices in fixed equipment such as switching device and industrial machine. The surge voltage withstand level of equipment for up to the rated voltage of 300V is 4000V.

* 2: This index indicates the degree to which conductive material is generated in the environment where the equipment is used. Pollution degree 2 is when non-conductive pollution occurs. However, temporary conductivity may be produced due to condensation.

* 3: The storage ambient temperature is -20 to 75°C if the system includes any CC-Link safety relay modules or extension safety relay modules.

* 4: Do not use or store the programmable controller under pressure higher than the atmospheric pressure of altitude 0m. Doing so may cause a malfunction. When using the programmable controller under pressure, please contact your local Mitsubishi office.

3.2 Q Series Safety Relay Module Specifications

This section explains the specifications of the Q series safety relay module.

3.2.1 QS90SR2SP-Q Q series safety relay module

Table 3.2 Performance specifications of QS90SR2SP-Q (1/2)

Item		Q series safety relay module			
		QS90SR2SP-Q			
		Input specifications		Output specifications	
Number of safety input points		1 safety input point (2 inputs)		Number of safety output points	
Number of other input points		1 start-up input point		1 safety output point (3 outputs)	
Insulation method		Relay insulation		Relay insulation	
Safety input rated input voltage		24VDC		Rated load current	
Safety input rated input current		4.6mA (300mA at relay start-up)		Category 3: 5.0A/point or less Category 4: 3.6A/point or less*1	
Operating voltage range		20.4 to 26.4VDC (ripple ratio: within 5%)		Minimum switching load	
				5VDC/5mA	
Input format		Type		Maximum allowable voltage of contact	
		P type		250VAC, 30VDC	
		X0		Resistance load	
		Positive common		250VAC/5A, 30VDC/5A	
		X1		Inductive load	
		Positive common		240VAC/2A (cos ϕ = 0.3) 24VDC/1A (L/R = 48ms)	
Relay life		Mechanical		Five million times or more	
		Electrical		Hundred thousand times or more	
Maximum switching frequency		1,200 times/hour based on the rated control capacity			
Response time		Time until output ON		50ms or less (safety input ON → safety output ON)*2	
		Time until output OFF		20ms or less (safety input OFF → safety output OFF)	
Common wiring method		All safety inputs and safety outputs are independent.			
Number of extension modules		Up to three extension safety relay modules can be connected.			
Number of occupied I/O points		32 points, 2 slots (I/O assignment: Input)			
Internal current consumption (5VDC)		0.09A			
Module power supply		Voltage		20.4 to 26.4VDC (ripple ratio: within 5%)	
		Current		35mA (when not using extension module), 110mA (when using three extension modules)	
Safety power supply		Voltage		20.4 to 26.4VDC (ripple ratio: within 5%)	
		Current		85mA (when not using extension module), 325mA (when using three extension modules)	
Noise durability		DC type noise voltage: 500Vp-p, noise width: 1 μ s, noise frequency: 25 to 60Hz (noise simulator condition)			
Dielectric withstand voltage		2,500VAC/1mA or less for 1 minute between safety outputs			
		2,500VAC/1mA or less for 1 minute between safety input and safety output			
		2,500VAC/1mA or less for 1 minute between power supply and safety output			
Insulation resistance		100M Ω or more, measured with a 500VDC insulation resistance tester between safety outputs			
		100M Ω or more, measured with a 500VDC insulation resistance tester between safety input and safety output			
		100M Ω or more, measured with a 500VDC insulation resistance tester between power supply and safety output			
Level of protection		IP1X			
Weight		0.37kg			
External connection method		Two-piece spring clamp terminal block			
Applicable wire size		Safety input part Start-up input part Safety power supply part Module power supply part		AWG: 24 to 18, single wire: 0.5 to 0.9mm, twisted wire: 0.2 to 0.75mm ²	
		Extension communication part terminal block Safety output part terminal block		AWG: 24 to 14, single wire: 0.5 to 1.78mm, twisted wire: 0.2 to 2.5mm ²	
Applicable solderless terminal (bar terminal)		Refer to Section 5.4.			

* 1: Category 4 is complied only when connecting a light curtain of Type 4.

* 2: Manual operation such as start-up switch operation is excluded.

Table 3.2 Performance specifications of QS90SR2SP-Q (2/2)

External connection diagram	Connector	Pin number	Signal name
	Module power supply part	1	+24V (UNIT)
		2	
		3	24G (UNIT)
		4	
		5	FG
	Extension communication part	1	EA
		2	EB
		3	EG
		4	SLD
		5	EP
	Safety input part	1	+24V (SAFETY)
		2	24G (SAFETY)
		3	XS0
		4	XS1
		5	COM0
		6	X0
		7	COM1
		8	X1
	Safety output part	1	Z00
		2	Z01
		3	Z10
		4	Z11
		5	Z20
		6	Z21

* 3: When connecting an electromagnetic switch and such for output, connect its normally closed contacts in series between XS0 and XS1.

* 4: Do not connect equipment other than a switch or sensor to each terminal of X0, X1, XS0, and XS1.

3.2.2 QS90SR2SN-Q Q series safety relay module

Table 3.3 Performance specifications of QS90SR2SN-Q (1/2)

Item	Q series safety relay module				
	QS90SR2SN-Q				
Input specifications		Output specifications			
Number of safety input points	1 safety input point (2 inputs)		Number of safety output points	1 safety output point (3 outputs)	
Number of other input points	1 start-up input point		Insulation method	Relay insulation	
Insulation method	Relay insulation		Rated load current	Category 4: 3.6A/point or less (Category 3: 5.0A/point or less)	
Safety input rated input voltage	24VDC				
Safety input rated input current	4.6mA (300mA at relay start-up)		Minimum switching load	5VDC/5mA	
Operating voltage range	20.4 to 26.4VDC (ripple ratio: within 5%)		Maximum allowable voltage of contact	250VAC, 30VDC	
Input format	Type	N type		Resistance load	250VAC/5A, 30VDC/5A
	X0	Positive common			Inductive load
	X1	Negative common			
Relay life	Mechanical	Five million times or more			
	Electrical	Hundred thousand times or more			
Maximum switching frequency	1,200 times/hour based on the rated control capacity				
Response time	Time until output ON	50ms or less (safety input ON → safety output ON)* ¹			
	Time until output OFF	20ms or less (safety input OFF → safety output OFF)			
Common wiring method	All safety inputs and safety outputs are independent.				
Number of extension modules	Up to three extension safety relay modules can be connected.				
Number of occupied I/O points	32 points, 2 slots (I/O assignment: Input)				
Internal current consumption (5VDC)	0.09A				
Module power supply	Voltage	20.4 to 26.4VDC (ripple ratio: within 5%)			
	Current	35mA (when not using extension module), 110mA (when using three extension modules)			
Safety power supply	Voltage	20.4 to 26.4VDC (ripple ratio: within 5%)			
	Current	85mA (when not using extension module), 325mA (when using three extension modules)			
Noise durability	DC type noise voltage: 500Vp-p, noise width: 1μs, noise frequency: 25 to 60Hz (noise simulator condition)				
Dielectric withstand voltage	2,500VAC/1mA or less for 1 minute between safety outputs 2,500VAC/1mA or less for 1 minute between safety input and safety output 2,500VAC/1mA or less for 1 minute between power supply and safety output				
Insulation resistance	100MΩ or more, measured with a 500VDC insulation resistance tester between safety outputs				
	100MΩ or more, measured with a 500VDC insulation resistance tester between safety input and safety output				
	100MΩ or more, measured with a 500VDC insulation resistance tester between power supply and safety output				
Level of protection	IP1X				
Weight	0.37kg				
External connection method	Two-piece spring clamp terminal block				
Applicable wire size	Safety input part Start-up input part Safety power supply part Module power supply part Extension communication part terminal block	AWG: 24 to 18, single wire: 0.5 to 0.9mm, twisted wire: 0.2 to 0.75mm ²			
	Safety output part terminal block	AWG: 24 to 14, single wire: 0.5 to 1.78mm, twisted wire: 0.2 to 2.5mm ²			
Applicable solderless terminal (bar terminal)	Refer to Section 5.4.				

* 1: Manual operation such as start-up switch operation is excluded.

Table 3.3 Performance specifications of QS90SR2SN-Q (2/2)

External connection diagram	Connector	Pin number	Signal name
<p>The diagram illustrates the external connections for the QS90SR2SN-Q module. It is divided into four main sections: <ul style="list-style-type: none"> Module power supply part: Shows a 24VDC (UNIT) source connected to pins +24V (UNIT), 24G (UNIT), and FG. A 5A fuse and a 0.9A thermal fuse (TH) are connected in series with the +24V line before it reaches a DC/DC converter. Extension communication part: Shows a multi-line communication bus connected to pins EA, EB, EG, SLD, and EP. This bus is linked to a Monitor circuit and a Q bus I/F circuit. Safety input part: Shows safety-related inputs connected to pins +24V (SAFETY), 24G (SAFETY), XS0, XS1, COM0, X0, COM1, and X1. These inputs are connected to a Start-up switch (MC0, MC1), a Safety limit switch (Safety door), and an Internal safety circuit. The internal circuit includes relays K0 and K1. Safety output part: Shows safety-related outputs connected to pins Z00, Z01, Z10, Z11, Z20, and Z21. These outputs are connected to a Safety relay (MC0, MC1) which controls a Motor (M). </p>	Module power supply part	1	+24V (UNIT)
		2	
		3	24G (UNIT)
		4	
		5	FG
	Extension communication part	1	EA
		2	EB
		3	EG
		4	SLD
		5	EP
	Safety input part	1	+24V (SAFETY)
		2	24G (SAFETY)
		3	XS0
		4	XS1
		5	COM0
		6	X0
		7	COM1
		8	X1
	Safety output part	1	Z00
		2	Z01
		3	Z10
		4	Z11
		5	Z20
		6	Z21

* 2: When connecting an electromagnetic switch and such for output, connect its normally closed contacts in series between XS0 and XS1.

* 3: Do not connect equipment other than a switch or sensor to each terminal of X0, X1, XS0, and XS1.

3.3 CC-Link Safety Relay Module Specifications

This section explains the specifications of the CC-Link safety relay module.

3.3.1 QS90SR2SP-CC CC-Link safety relay module

Table 3.4 Performance specifications of QS90SR2SP-CC (1/2)

Item	CC-Link safety relay module					
	QS90SR2SP-CC					
Input specifications		Output specifications				
Number of safety input points	1 safety input point (2 inputs)		Number of safety output points	1 safety output point (3 outputs)		
Number of other input points	1 start-up input point		Insulation method	Relay insulation		
Insulation method	Relay insulation		Rated load current	Category 3: 5.0A/point or less Category 4: 3.6A/point or less ^{*1}		
Safety input rated input voltage	24VDC			Minimum switching load	5VDC/5mA	
Safety input rated input current	4.6mA (300mA at relay start-up)		Maximum allowable voltage of contact	250VAC, 30VDC		
Operating voltage range	20.4 to 26.4VDC (ripple ratio: within 5%)					
Input format	Type	P type	Rated load	Resistance load	250VAC/5A, 30VDC/5A	
	X0	Positive common		Inductive load	240VAC/2A (cosφ = 0.3) 24VDC/1A (L/R = 48ms)	
	X1	Positive common				
Relay life	Mechanical	Five million times or more				
	Electrical	Hundred thousand times or more				
Maximum switching frequency	1,200 times/hour based on the rated control capacity					
Response time	Time until output ON	50ms or less (safety input ON → safety output ON) ^{*2}				
	Time until output OFF	20ms or less (safety input OFF → safety output OFF)				
Common wiring method	All safety inputs and safety outputs are independent.					
Number of extension modules	Up to three extension safety relay modules can be connected.					
Number of occupied stations	32-point assigned per station (32 points used)					
Module power supply	Voltage	20.4 to 26.4VDC (ripple ratio: within 5%)				
	Current	70mA (when not using extension module), 145mA (when using three extension modules)				
Safety power supply	Voltage	20.4 to 26.4VDC (ripple ratio: within 5%)				
	Current	85mA (when not using extension module), 325mA (when using three extension modules)				
Noise durability	DC type noise voltage: 500Vp-p, noise width: 1μs, noise frequency: 25 to 60Hz (noise simulator condition)					
Dielectric withstand voltage	2,500VAC/1mA or less for 1 minute between safety outputs					
	2,500VAC/1mA or less for 1 minute between safety input and safety output					
	2,500VAC/1mA or less for 1 minute between power supply and safety output					
Insulation resistance	100MΩ or more, measured with a 500VDC insulation resistance tester between safety outputs					
	100MΩ or more, measured with a 500VDC insulation resistance tester between safety input and safety output					
	100MΩ or more, measured with a 500VDC insulation resistance tester between power supply and safety output					
Level of protection	IP1X					
Weight	0.37kg					
External connection method	Two-piece spring clamp terminal block					
Applicable wire size	Safety input part Start-up input part Safety power supply part Safety output part terminal block	AWG: 24 to 14, single wire: 0.5 to 1.78mm, twisted wire: 0.2 to 2.5mm ²				
	CC-Link part Extension communication part terminal block	AWG: 24 to 16, single wire: 0.5 to 1.2mm, twisted wire: 0.2 to 1.25mm ²				
Applicable solderless terminal (bar terminal)	Refer to Section 5.4.					
Applicable DIN rail	TH35-7.5Fe, TH35-7.5Al (JIS C 2812 compliant)					

* 1: Category 4 is complied only when connecting a light curtain of Type 4.

* 2: Manual operation such as start-up switch operation is excluded.

Table 3.4 Performance specifications of QS90SR2SP-CC (2/2)

External connection diagram	Connector	Pin number	Signal name
	Module power supply part	1	+24V (UNIT)
		2	
		3	24G (UNIT)
		4	
	CC-Link part	1	DA
		2	DB
		3	DG
		4	SLD
	Extension communication part	1	EA
		2	EB
		3	EG
		4	EP
	Safety power supply, start-up input part	1	XS0
		2	XS1
		3	+24V (SAFETY)
		4	24G (SAFETY)
	Safety input part	1	COM
		2	X0
		3	COM
		4	X1
Safety output part 1	1	Empty	
	2	Z00	
	3	Z10	
	4	Z20	
Safety output part 2	1	Empty	
	2	Z01	
	3	Z11	
	4	Z21	

* 3: When connecting an electromagnetic switch and such for output, connect its normally closed contacts in series between XS0 and XS1.

* 4: Do not connect equipment other than a switch or sensor to each terminal of X0, X1, XS0, and XS1.

3.3.2 QS90SR2SN-CC CC-Link safety relay module

Table 3.5 Performance specifications of QS90SR2SN-CC (1/2)

Item	CC-Link safety relay module			
	QS90SR2SN-CC			
Input specifications		Output specifications		
Number of safety input points	1 safety input point (2 inputs)		Number of safety output points	1 safety output point (3 outputs)
Number of other input points	1 start-up input point		Insulation method	Relay insulation
Insulation method	Relay insulation		Rated load current	Category 4: 3.6A/point or less (Category 3: 5.0A/point or less)
Safety input rated input voltage	24VDC			
Safety input rated input current	4.6mA (300mA at relay start-up)		Minimum switching load	5VDC/5mA
Operating voltage range	20.4 to 26.4VDC (ripple ratio: within 5%)		Maximum allowable voltage of contact	250VAC, 30VDC
Input format	Type	N type		Resistance load
	X0	Positive common		
	X1	Negative common		250VAC/5A, 30VDC/5A
Relay life	Mechanical	Five million times or more		
	Electrical	Hundred thousand times or more		
Maximum switching frequency	1,200 times/hour based on the rated control capacity			
Response time	Time until output ON	50ms or less (safety input ON → safety output ON)* ¹		
	Time until output OFF	20ms or less (safety input OFF → safety output OFF)		
Common wiring method	All safety inputs and safety outputs are independent.			
Number of extension modules	Up to three extension safety relay modules can be connected.			
Number of occupied stations	32-point assigned per station (32 points used)			
Module power supply	Voltage	20.4 to 26.4VDC (ripple ratio: within 5%)		
	Current	70mA (when not using extension module), 145mA (when using three extension modules)		
Safety power supply	Voltage	20.4 to 26.4VDC (ripple ratio: within 5%)		
	Current	85mA (when not using extension module), 325mA (when using three extension modules)		
Noise durability	DC type noise voltage: 500Vp-p, noise width: 1μs, noise frequency: 25 to 60Hz (noise simulator condition)			
Dielectric withstand voltage	2,500VAC/1mA or less for 1 minute between safety outputs 2,500VAC/1mA or less for 1 minute between safety input and safety output 2,500VAC/1mA or less for 1 minute between power supply and safety output			
Insulation resistance	100MΩ or more, measured with a 500VDC insulation resistance tester between safety outputs			
	100MΩ or more, measured with a 500VDC insulation resistance tester between safety input and safety output			
	100MΩ or more, measured with a 500VDC insulation resistance tester between power supply and safety output			
Level of protection	IP1X			
Weight	0.37kg			
External connection method	Two-piece spring clamp terminal block			
Applicable wire size	Safety input part Start-up input part Safety power supply part Safety output part terminal block	AWG: 24 to 14, single wire: 0.5 to 1.78mm, twisted wire: 0.2 to 2.5mm ²		
	CC-Link part Extension communication part terminal block	AWG: 24 to 16, single wire: 0.5 to 1.2mm, twisted wire: 0.2 to 1.25mm ²		
Applicable solderless terminal (bar terminal)	Refer to Section 5.4.			
Applicable DIN rail	TH35-7.5Fe, TH35-7.5Al (JIS C 2812 compliant)			

* 1: Manual operation such as start-up switch operation is excluded.

Table 3.5 Performance specifications of QS90SR2SN-CC (2/2)

External connection diagram	Connector	Pin number	Signal name
	Module power supply part	1	+24V (UNIT)
		2	
		3	24G (UNIT)
		4	
	CC-Link part	1	DA
		2	DB
		3	DG
		4	SLD
	Extension communication part	1	EA
		2	EB
		3	EG
		4	EP
	Safety power supply, start-up input part	1	XS0
		2	XS1
		3	+24V (SAFETY)
		4	24G (SAFETY)
	Safety input part	1	COM
		2	X0
		3	COM
		4	X1
Safety output part 1	1	Empty	
	2	Z00	
	3	Z10	
	4	Z20	
Safety output part 2	1	Empty	
	2	Z01	
	3	Z11	
	4	Z21	

* 2: When connecting an electromagnetic switch and such for output, connect its normally closed contacts in series between XS0 and XS1.

* 3: Do not connect equipment other than a switch or sensor to each terminal of X0, X1, XS0, and XS1.

3.4 Extension Safety Relay Module Specifications

This section explains the specifications of the extension safety relay module.

3.4.1 QS90SR2SP-EX extension safety relay module

Table 3.6 Performance specifications of QS90SR2SP-EX (1/2)

Item	Extension safety relay module			
	QS90SR2SP-EX			
Input specifications		Output specifications		
Number of safety input points	1 safety input point (2 inputs)		Number of safety output points	1 safety output point (3 outputs)
Number of other input points	1 start-up input point		Insulation method	Relay insulation
Insulation method	Relay insulation		Rated load current	Category 3: 5.0A/point or less
Safety input rated input voltage	24VDC			Category 4: 3.6A/point or less ^{*1}
Safety input rated input current	4.6mA		Minimum switching load	5VDC/5mA
Operating voltage range	20.4 to 26.4VDC (ripple ratio: within 5%)		Maximum allowable voltage of contact	250VAC, 30VDC
Input format	Type	P type		Resistance load
	X0	Positive common		
	X1	Positive common		Inductive load
Relay life	Mechanical	Five million times or more		
	Electrical	Hundred thousand times or more		24VDC/1A (L/R = 48ms)
Maximum switching frequency	1,200 times/hour based on the rated control capacity			
Response time	Time until output ON	50ms or less (safety input ON → safety output ON) ^{*2}		
	Time until output OFF	20ms or less (safety input OFF → safety output OFF)		
Common wiring method	All safety inputs and safety outputs are independent.			
Module power supply	Voltage	Supplied from Q series safety relay module or CC-Link safety relay module.		
Safety power supply	Voltage	Supplied from Q series safety relay module or CC-Link safety relay module.		
Noise durability	DC type noise voltage: 500Vp-p, noise width: 1μs, noise frequency: 25 to 60Hz (noise simulator condition)			
Dielectric withstand voltage	2,500VAC/1mA or less for 1 minute between safety outputs			
	2,500VAC/1mA or less for 1 minute between safety input and safety output			
	2,500VAC/1mA or less for 1 minute between power supply and safety output			
Insulation resistance	100MΩ or more, measured with a 500VDC insulation resistance tester between safety outputs			
	100MΩ or more, measured with a 500VDC insulation resistance tester between safety input and safety output			
	100MΩ or more, measured with a 500VDC insulation resistance tester between power supply and safety output			
Level of protection	IP1X			
Weight	0.35kg			
External connection method	Two-piece spring clamp terminal block			
Applicable wire size	Safety input part Start-up input part Safety power supply part Safety output part terminal block	AWG: 24 to 14, single wire: 0.5 to 1.78mm, twisted wire: 0.2 to 2.5mm ²		
	Extension communication part terminal block	AWG: 24 to 16, single wire: 0.5 to 1.2mm, twisted wire: 0.2 to 1.25mm ²		
Applicable solderless terminal (bar terminal)	Refer to Section 5.4.			
Applicable DIN rail	TH35-7.5Fe, TH35-7.5Al (JIS C 2812 compliant)			

* 1: Category 4 is complied only when connecting a light curtain of Type 4.

* 2: Manual operation such as start-up switch operation is excluded.

Table 3.6 Performance specifications of QS90SR2SP-EX (2/2)

External connection diagram	Connector	Pin number	Signal name
	Extension communication part	1	EA
		2	EB
		3	EG
		4	EP
	Start-up input part	1	XS0
		2	XS1
		3	Empty
	Safety input part	4	Empty
		1	COM
		2	X0
		3	COM
	Safety output part 1	4	X1
		1	Empty
		2	Z00
		3	Z10
	Safety output part 2	4	Z20
		1	Empty
		2	Z01
		3	Z11
			4

* 3: When connecting an electromagnetic switch and such for output, connect its normally closed contacts in series between XS0 and XS1.

* 4: Do not connect equipment other than a switch or sensor to each terminal of X0, X1, XS0, and XS1.

3.4.2 QS90SR2SN-EX extension safety relay module

Table 3.7 Performance specifications of QS90SR2SN-EX (1/2)

Item	Extension safety relay module			
	QS90SR2SN-EX			
Input specifications		Output specifications		
Number of safety input points	1 safety input point (2 inputs)		Number of safety output points	1 safety output point (3 outputs)
Number of other input points	1 start-up input point		Insulation method	Relay insulation
Insulation method	Relay insulation		Rated load current	Category 4: 3.6A/point or less (Category 3: 5.0A/point or less)
Safety input rated input voltage	24VDC			
Safety input rated input current	4.6mA		Minimum switching load	5VDC/5mA
Operating voltage range	20.4 to 26.4VDC (ripple ratio: within 5%)		Maximum allowable voltage of contact	250VAC, 30VDC
Input format	Type	N type		Resistance load
	X0	Positive common		
	X1	Negative common		250VAC/5A, 30VDC/5A
Relay life	Mechanical	Five million times or more		
	Electrical	Hundred thousand times or more		
Maximum switching frequency	1,200 times/hour based on the rated control capacity			
Response time	Time until output ON	50ms or less (safety input ON → safety output ON) ^{*1}		
	Time until output OFF	20ms or less (safety input OFF → safety output OFF)		
Common wiring method	All safety inputs and safety outputs are independent.			
Module power supply	Voltage	Supplied from Q series safety relay module or CC-Link safety relay module.		
Safety power supply	Voltage	Supplied from Q series safety relay module or CC-Link safety relay module.		
Noise durability	DC type noise voltage: 500Vp-p, noise width: 1μs, noise frequency: 25 to 60Hz (noise simulator condition)			
Dielectric withstand voltage	2,500VAC/1mA or less for 1 minute between safety outputs			
	2,500VAC/1mA or less for 1 minute between safety input and safety output			
	2,500VAC/1mA or less for 1 minute between power supply and safety output			
Insulation resistance	100MΩ or more, measured with a 500VDC insulation resistance tester between safety outputs			
	100MΩ or more, measured with a 500VDC insulation resistance tester between safety input and safety output			
	100MΩ or more, measured with a 500VDC insulation resistance tester between power supply and safety output			
Level of protection	IP1X			
Weight	0.35kg			
External connection method	Two-piece spring clamp terminal block			
Applicable wire size	Safety input part Start-up input part Safety power supply part Safety output part terminal block	AWG: 24 to 14, single wire: 0.5 to 1.78mm, twisted wire: 0.2 to 2.5mm ²		
	Extension communication part terminal block	AWG: 24 to 16, single wire: 0.5 to 1.2mm, twisted wire: 0.2 to 1.25mm ²		
Applicable solderless terminal (bar terminal)	Refer to Section 5.4.			
Applicable DIN rail	TH35-7.5Fe, TH35-7.5Al (JIS C 2812 compliant)			

* 1: Manual operation such as start-up switch operation is excluded.

Table 3.7 Performance specifications of QS90SR2SN-EX (2/2)

External connection diagram	Connector	Pin number	Signal name
	Extension communication part	1	EA
		2	EB
		3	EG
		4	EP
	Start-up input part	1	XS0
		2	XS1
		3	Empty
		4	Empty
	Safety input part	1	COM
		2	X0
		3	COM
		4	X1
	Safety output part 1	1	Empty
		2	Z00
		3	Z10
		4	Z20
	Safety output part 2	1	Empty
		2	Z01
		3	Z11
		4	Z21

* 2: When connecting an electromagnetic switch and such for output, connect its normally closed contacts in series between XS0 and XS1.

* 3: Do not connect equipment other than a switch or sensor to each terminal of X0, X1, XS0, and XS1.

3.5 I/O Signals

The following table shows the I/O signals of the safety relay module.

Table 3.8 List of I/O signals

Device number			Signal name	Description	
Module	Q series	CC-Link		ON	OFF
Main module	X0	RX0	X0: Safety input 0	Input	No input
	X1	RX1	X1: Safety input 1	Input	No input
	X2	RX2	Z: Safety output	Output	No output
	X3	RX3	XS: Start-up input	Input	No input
	X4	RX4	K0: Internal safety relay K0 drive (coil)	Relay drive	No relay drive
	X5	RX5	K1: Internal safety relay K1 drive (coil)	Relay drive	No relay drive
	X6	RX6	K0RB: Internal safety relay K0 output (contact) ^{*2}	Relay output	No relay output
	X7	RX7	K1RB: Internal safety relay K1 output (contact) ^{*2}	Relay output	No relay output
Extension module (station number 1)	X8	RX8	X0: Safety input 0 ^{*1}	Input	No input
	X9	RX9	X1: Safety input 1 ^{*1}	Input	No input
	XA	RXA	Z: Safety output	Output	No output
	XB	RXB	XS: Start-up input	Input	No input
	XC	RXC	K0: Internal safety relay K0 drive (coil)	Relay drive	No relay drive
	XD	RXD	K1: Internal safety relay K1 drive (coil)	Relay drive	No relay drive
	XE	RXE	K0RB: Internal safety relay K0 output (contact) ^{*2}	Relay output	No relay output
	XF	RXF	K1RB: Internal safety relay K1 output (contact) ^{*2}	Relay output	No relay output
Extension module (station number 2)	X10	RX10	X0: Safety input 0 ^{*1}	Input	No input
	X11	RX11	X1: Safety input 1 ^{*1}	Input	No input
	X12	RX12	Z: Safety output	Output	No output
	X13	RX13	XS: Start-up input	Input	No input
	X14	RX14	K0: Internal safety relay K0 drive (coil)	Relay drive	No relay drive
	X15	RX15	K1: Internal safety relay K1 drive (coil)	Relay drive	No relay drive
	X16	RX16	K0RB: Internal safety relay K0 output (contact) ^{*2}	Relay output	No relay output
	X17	RX17	K1RB: Internal safety relay K1 output (contact) ^{*2}	Relay output	No relay output
Extension module (station number 3)	X18	RX18	X0: Safety input 0 ^{*1}	Input	No input
	X19	RX19	X1: Safety input 1 ^{*1}	Input	No input
	X1A	RX1A	Z: Safety output	Output	No output
	X1B	RX1B	XS: Start-up input	Input	No input
	X1C	RX1C	K0: Internal safety relay K0 drive (coil)	Relay drive	No relay drive
	X1D	RX1D	K1: Internal safety relay K1 drive (coil)	Relay drive	No relay drive
	X1E	RX1E	K0RB: Internal safety relay K0 output (contact) ^{*2}	Relay output	No relay output
	X1F	RX1F	K1RB: Internal safety relay K1 output (contact) ^{*2}	Relay output	No relay output

* 1: The signal is always OFF regardless of the safety input status if the main module is not operating.

* 2: K0RB and K1RB indicate whether the actual safety relay contacts K0 and K1 are ON, respectively.

This allows a detection of welding of safety relay contact.

3.6 Cable Specifications

(1) Safety circuit part extension cables

Table 3.9 shows the specifications of cables used for adding a safety relay module. Use the following cable for adding the safety part. If using a cable other than the following, the operation is not guaranteed.

Table 3.9 Cable specifications

Name	Model
Safety circuit part extension cable	QS90CBL-SE01 (10cm (3.94 inch))
	QS90CBL-SE15 (1.5m (4.92 ft.))

(2) Monitor circuit part extension cables

Use shielded cables for the extension cable of monitor circuit part. For the Q series safety relay module, connect the shield to SLD terminal on the module, and for the CC-Link safety relay module, ground it from the control panel. Not doing so may cause a malfunction due to noise.

(3) Safety part terminating connector

This is a connector attached to the Q series safety relay module and CC-Link safety relay module. When adding a module, remove the safety part terminating connector and attach it to "OUT" side connector of the extension safety relay module on the last stage. If the connector is not attached, the module does not operate.

(4) CC-Link dedicated cables

Use CC-Link dedicated cables for the CC-Link system. The performance of the CC-Link system can not be guaranteed when any other cables are used. For the specifications or any other inquiries of CC-Link dedicated cables, visit the website; CC-Link Partner Association: <http://www.cc-link.org/>

Remark

Refer to the CC-Link cable wiring manual issued by the CC-Link Partner Association.

.....

CHAPTER4 FUNCTIONS

Table 4.1 shows the list of safety relay module functions.

Table 4.1 Function list

Function	Description	Reference
Dual input function	Prevents damage of the safety functions due to a single failure by doubling inputs. <ul style="list-style-type: none"> •Input N type: Dual input with positive common and negative common •Input P type: Dual input with positive commons In case of input N type, when between dual inputs shorts, a short occurs between the power supply and grounding, resulting in power-OFF with electric fuse.	Section 4.1
Start-up/off check function	Checks that status of the safety relay module and external device are normal.	Section 4.2
Start-up method selection function	Allows to select the start-up method either auto mode or manual mode with setting switch.	Section 4.3
Safety output function	Prevents incorrect output due to a single failure by doubling safety relay contacts internally.	Section 4.4
Monitor function	Allows to check operating status of the whole safety relay modules including extension safety relay modules by connecting with the programmable controller using programming tool.	Section 4.5
Partial shutdown function with extension module	Allows to shut off only the outputs of certain modules by using safety inputs of extension module.	Section 4.6

4.1 Dual Input Function

This function doubles safety inputs to prevent damage of the safety functions due to a single failure.

The doubled safety inputs operate after making sure that the internal module, external devices, and wiring are normal by the start-up/off check function. Briefly, if a module, external devices or wiring has a failure, the module does not start.

After module start-up, if one safety input does not turn OFF due to a failure, the output is cut off by turn-OFF of the other safety input.

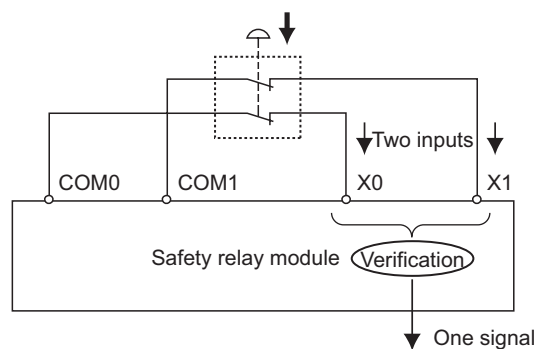

Figure 4.1 Dual input wiring

4.2 Start-up/off Check Function

This function is to start the system after making sure that status of the safety relay module and external device are normal.

When the safety relay and electromagnetic switch are connected, connecting the normally closed contacts to the start-up/off check terminal of the safety relay module inhibiting the start-up at a failure such as contact welding.

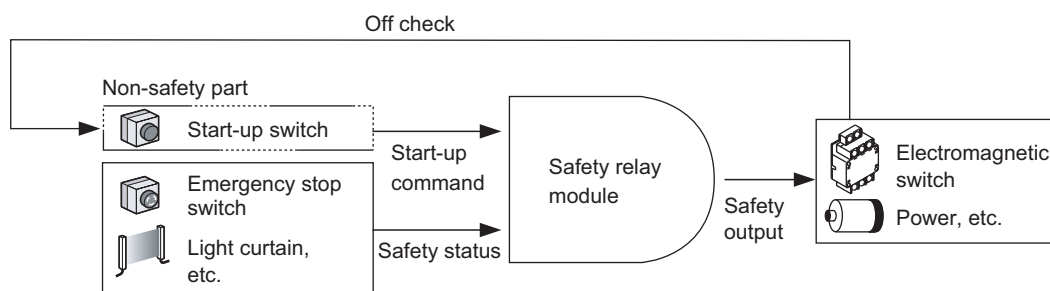

Figure 4.2 Off check function

POINT

- Connect normally closed contact of forcibly guided type electromagnetic switch to off check.
- If connecting normally closed contact of electromagnetic switch other than forcibly guided type, contact separation of the electromagnetic switch cannot be detected.
- Wire the start-up/off check input so that the external wiring length can be 50m (164.04 feet) or less.
- The timing of safety input and start-up/off check are inconstant.
- Therefore, control using this timing cannot be made.

4.3 Start-up Method Selection Function

This function allows to select the start-up method with start-up setting switch. The start-up method has auto mode and manual mode.

(1) Auto mode

This mode starts immediately after safety input and off check are all met. Set the start-up setting switch to "A" side. Use this mode when connecting such as door switch.

(2) Manual mode

This mode starts by pressing the start-up switch when safety input and external device connected to the start-up/off check terminal are all met. The mode starts after the start-up input turns from ON to OFF to prevent a malfunction due to contact welding of the start-up switch. Set the start-up setting switch to "M" side. Use this mode when connecting such as operation preparation switch.

☒ POINT

- Never use the start-up switch during the auto mode.
- Doing so may cause a malfunction or failure of the module.
- According to the standard, the system cannot start at the auto mode for operation preparation or when using the light curtain.
- In this case, connect the start-up switch or recovery reset switch and use it in the manual mode.
- When using the start-up switch during the manual mode, always use the momentary type of NO (normal open).
- Connect the normally closed contact of forcibly guided type to off check input.
If using other than mentioned above, it may cause a malfunction or failure of the module.

4.4 Safety Output Function

This function prevents incorrect output due to a single failure by doubling safety relay outputs internally.

The output can be stopped even if the one contact fails due to welding. Moreover, once a contact fails due to welding, the system does not start after that; therefore, the safety is not damaged.

4.5 Monitor Function

This function allows to check operating status of the whole safety relay modules including extension safety relay modules by connecting with the programmable controller using programming tool.

Each module status can be checked as 32-point input from the CPU module.

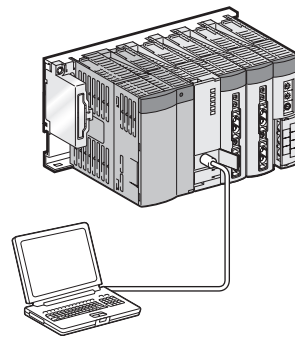

Personal computer
(GX Developer)

Figure 4.3 Monitor function

(1) Don't in the monitor function

Configuring a safety circuit using the monitor result of safety status with non-safety device such as programmable controller is inhibited.

Do not use device information gained from the monitor function for controlling safety devices.

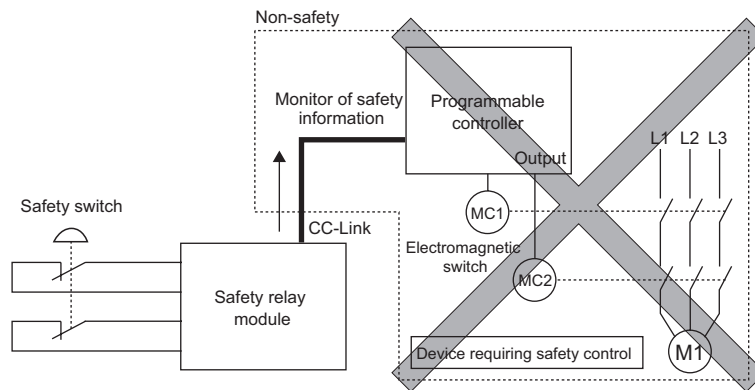

4.6 Partial Shutdown Function with Extension Module

This function allows to shut off only the outputs of extension module by using safety inputs of extension module.

By shutting off only the necessary parts, operating rate of equipment and production line can be raised.

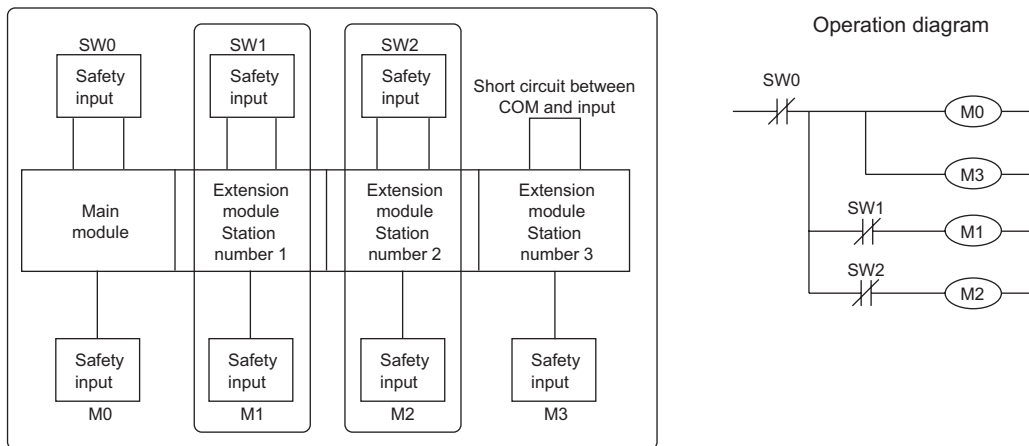

Figure 4.4 Partial shutdown with extension module

The following shows an operation example when the safety relay module system in Figure 4.4 is configured.

- If SW0, safety input switch of the main module, is pressed, the whole outputs (M0, M1, M2, M3) are shut off.
- If SW1, safety input switch of the extension module on station number 1, is pressed, only output of the extension module (M1) is shut off.
- By shorting the safety input of the extension module on station number 3, the safety input is synchronized with the safety output of the main module and is driven/shut off.

POINT

The safety output of the extension module can be synchronized only with main module: therefore; it cannot be synchronized with another extension module.

CHAPTER5 SETTINGS AND PROCEDURES BEFORE OPERATION

This chapter explains settings and procedures before operating the safety relay module.

5.1 Q Series Safety Relay Module

5.1.1 Start-up procedures

Figure 5.1 shows start-up procedures for the Q series safety relay module.

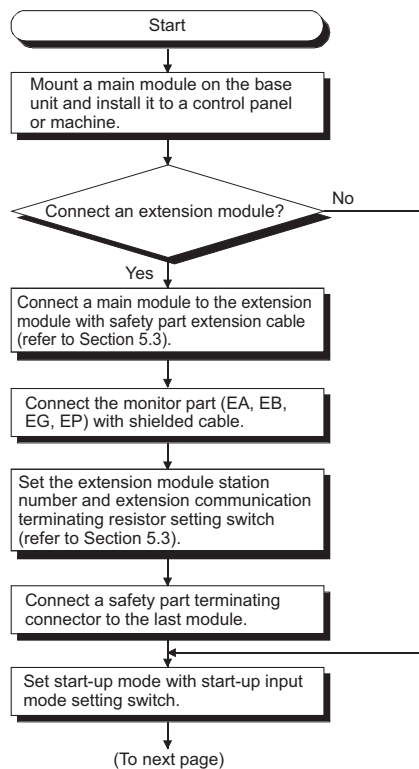

Figure 5.1 Start-up procedures (1/2)

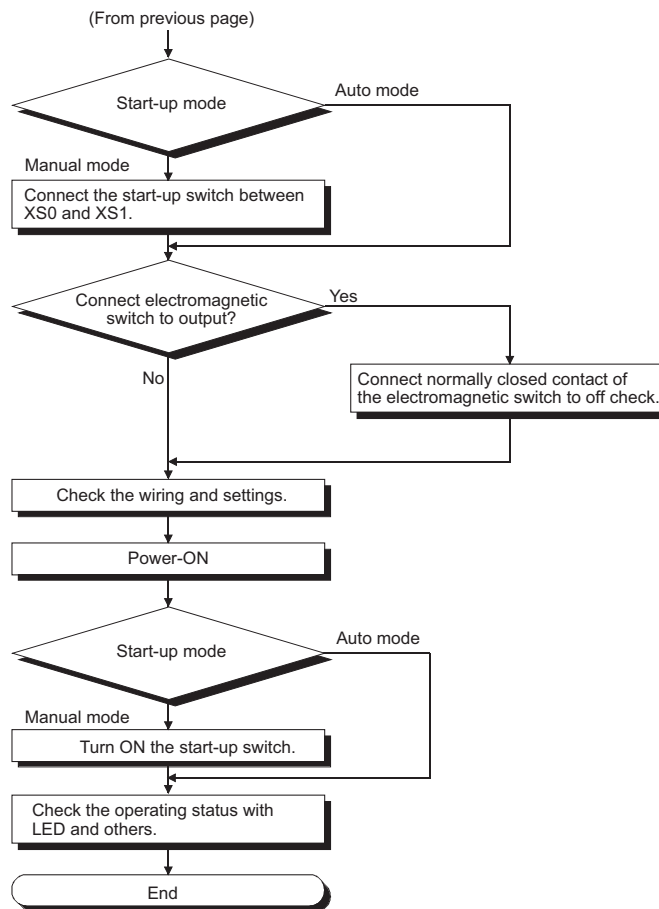

Figure 5.1 Start-up procedures (2/2)

POINT

When powering ON the system, make sure to power ON the safety power supply first, and then the module power supply.

If the module power supply is powered ON first, monitor signals cannot be read properly.

For details, refer to Section 6.1.

5.1.2 Handling precautions

This section explains handling precautions for the Q series safety relay module.



DANGER

- Do not touch the terminals while power is on.
Doing so could result in electric shock.
- Turn off all phases of the external supply power used in the system when cleaning the module or retightening the terminal block mounting screws, terminal screws, or module mounting screws.
Not doing so could result in electric shock.
Tighten a terminal block mounting screw and module mounting screw within the specified torque range.
If the terminal block mounting screw is too loose, it may cause a short-circuit, fire or malfunctions.
If too tight, it may damage the screw and/or the module, resulting in a drop of the screw or module, a short circuit or malfunctions.
If the module mounting screw is too loose, it may cause a drop of the screw or module.
Over tightening the screw may cause a drop due to the damage of the screw or module.



CAUTION

- Be sure there are no foreign substances such as sawdust or wiring debris inside the module.
Such debris could cause a fire, failure, or malfunctions.
- Do not disassemble or remodel the module.
Doing so could cause a failure, malfunctions, injury, or fire.
If the product is repaired or remodeled by other than the specified FA centers or us, the warranty is not covered.
- Do not directly touch the module's conductive parts or electronic components.
Doing so may cause malfunctions or a failure.
- When disposing of this product, treat it as industrial waste.

(1) Module fixing screw

Tighten the module fixing screws and terminal block mounting screws within the following torque range.

Screw	Specified torque range
Module fixing screw (M3)	0.36 to 0.48N · m
Terminal block mounting screw (M2.6)	0.40 to 0.50N · m

5.1.3 Part names and settings

This section explains each part name of the Q series safety relay module.

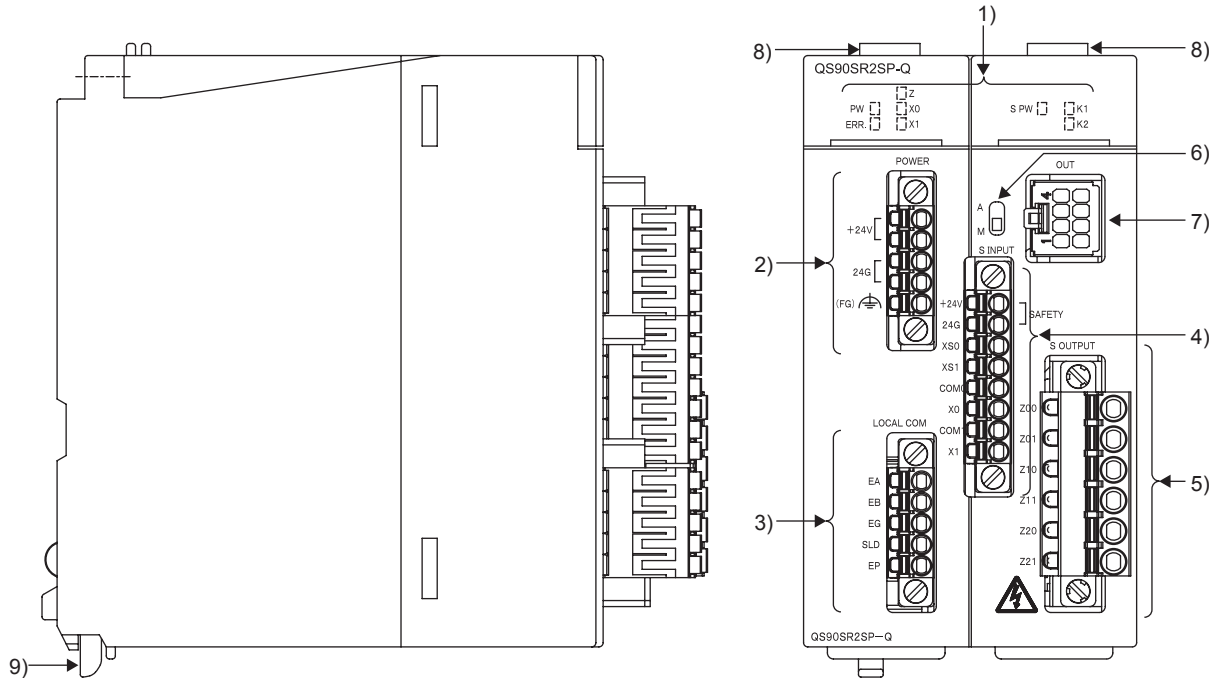

Figure 5.2 Q series safety relay module

Table 5.1 Part names (1/2)

Number	Name	Description
1)	Indicator LED	PW Indicates status of module power supply. ON: Module power supply is supplied. OFF: Module power supply is cut off or electric fuse functions.
		ERR. Indicates a failure in the monitor function of a module or an error in communications with the extension module. ON: An error occurred in communications with the extension safety relay module. OFF: Normal
		Z Indicates status of safety output. ON: Safety output is generated (both K0 and K1 are ON). OFF: Safety output is not generated.
		X0 Indicates status of safety input (X0, X1).
		X1 ON: Safety input is generated. OFF: Safety input is not generated.
		S PW Indicates status of safety power supply. ON: Safety power supply is supplied. OFF: Safety power supply is cut off or electric fuse functions.
		K0 Indicates operating status of the internal safety relay K0 (coil status of K0). ON: Operating status of the internal safety relay K0 is ON. OFF: Operating status of the internal safety relay K0 is OFF.
K1 Indicates operating status of the internal safety relay K1 (coil status of K1). ON: Operating status of the internal safety relay K1 is ON. OFF: Operating status of the internal safety relay K1 is OFF.		

Table 5.1 Part names (2/2)

Number	Name		Description
2)	Module power supply part terminal block	POWER	+ 24V: Module power supply + 24V terminal 24G: Module power supply 24G terminal FG: Module power supply FG terminal
3)	Extension communication part terminal block	LOCAL COM	EA, EB, EG: Data terminal for extension communication SLD: Shielding wire terminal EP: Power supply terminal for extension module
4)	Safety power supply, safety input part terminal block	S INPUT	+ 24V: Safety part power supply + 24V terminal 24G: Safety part power supply 24G terminal XS0, XS1: Start-up/off check terminal X0: Safety input X0 input terminal COM: Safety input X0 COM terminal X1: Safety input X1 input terminal COM: Safety input X1 COM terminal
5)	Safety output part terminal block	S OUTPUT	Z00, Z01: Safety relay output terminal Z10, Z11: Safety relay output terminal Z20, Z21: Safety relay output terminal
6)	Start-up mode setting switch		A switch for setting start-up-mode "A" side: Auto mode "M" side: Manual mode
7)	Safety part extension connector	OUT	A connector for connecting an extension module
8)	Module fixing hook		A hook for fixing a module to a base unit (One-touch installation)
9)	Module mounting lever		A lever for mounting a module on a base unit

5.1.4 Mounting/removal

For mounting/removing the Q series safety relay module on/from the base unit, refer to the QCPU User's Manual (Hardware Design, Maintenance and Inspection).

5.2 CC-Link Safety Relay Module

5.2.1 Start-up procedures

Figure 5.3 shows start-up procedures for the CC-Link safety relay module.

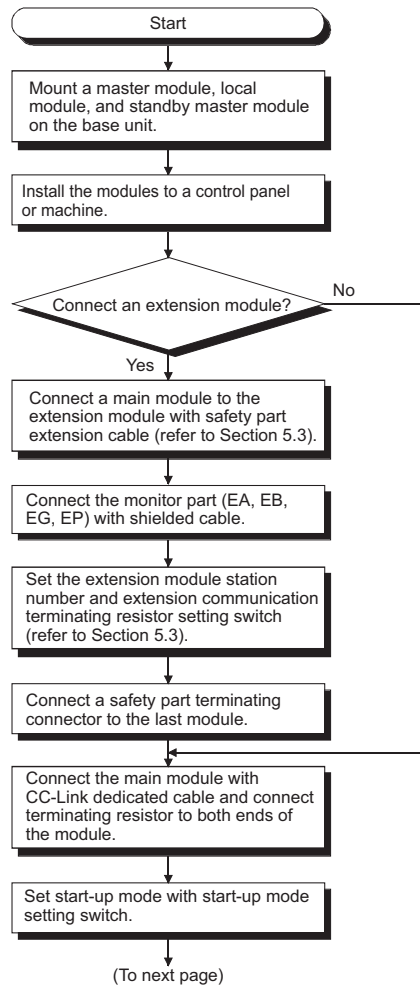

Figure 5.3 Start-up procedures (1/2)

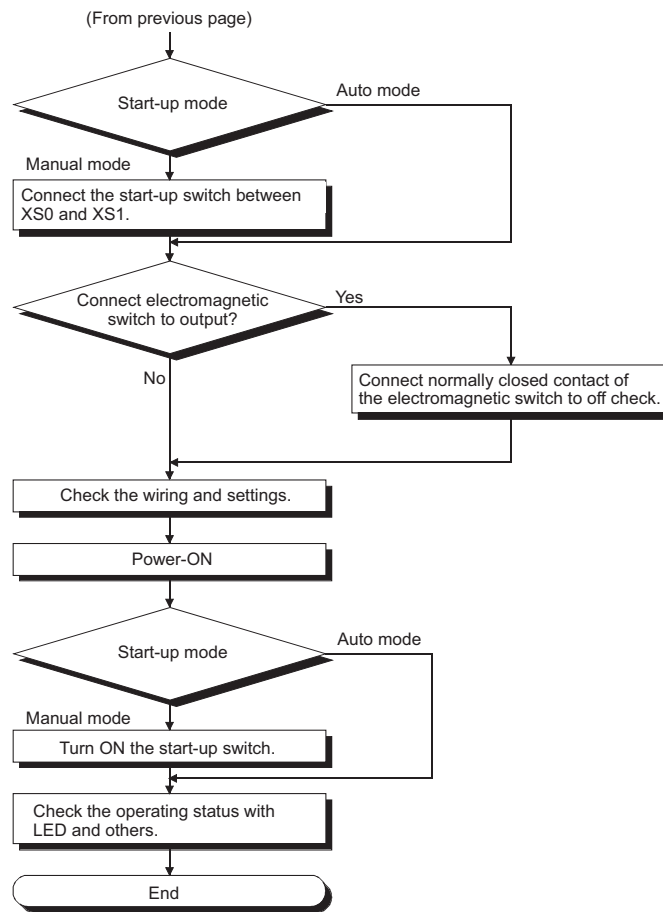

Figure 5.3 Start-up procedures (2/2)

POINT

When powering ON the system, make sure to power ON the safety power supply first, and then the module power supply.

If the module power supply is powered ON first, monitor signals cannot be read properly.

For details, refer to Section 6.2.

5.2.2 Handling precautions

This section explains handling precautions for the CC-Link safety relay module.

 DANGER	<ul style="list-style-type: none">● Do not touch the terminals while power is on. Doing so could result in electric shock.● Turn off all phases of the external supply power used in the system when cleaning the module or retightening the terminal block mounting screws. Not doing so could result in electric shock. Tighten a terminal block mounting screw within the specified torque range. If the terminal block mounting screw is too loose, it may cause a short-circuit, fire or malfunctions. If too tight, it may damage the screw and/or the module, resulting in a drop of the screw or module, a short circuit or malfunctions.
---	--

 CAUTION	<ul style="list-style-type: none">● Be sure there are no foreign substances such as sawdust or wiring debris inside the module. Such debris could cause a fire, failure, or malfunctions.● Do not disassemble or remodel the module. Doing so could cause a failure, malfunctions, injury, or fire. If the product is repaired or remodeled by other than the specified FA centers or us, the warranty is not covered.● Do not directly touch the module's conductive parts or electronic components. Doing so may cause malfunctions or a failure.● When disposing of this product, treat it as industrial waste.
---	---

(1) Mounting DIN rail

When mounting a DIN rail, pay attention to the following:

- (a) Applicable DIN rail model (JIS C 2812 compliant)
 - TH35-7.5Fe
 - TH35-7.5Al
- (b) DIN rail mounting screw interval
 - Mount the DIN rail with screws at intervals of 200mm (7.87 inch) or less.
- (c) DIN rail fixing bracket
 - Securely fix a module with a DIN rail fixing bracket.

5.2.3 Part names and settings

This section explains each part name of the CC-Link safety relay module.

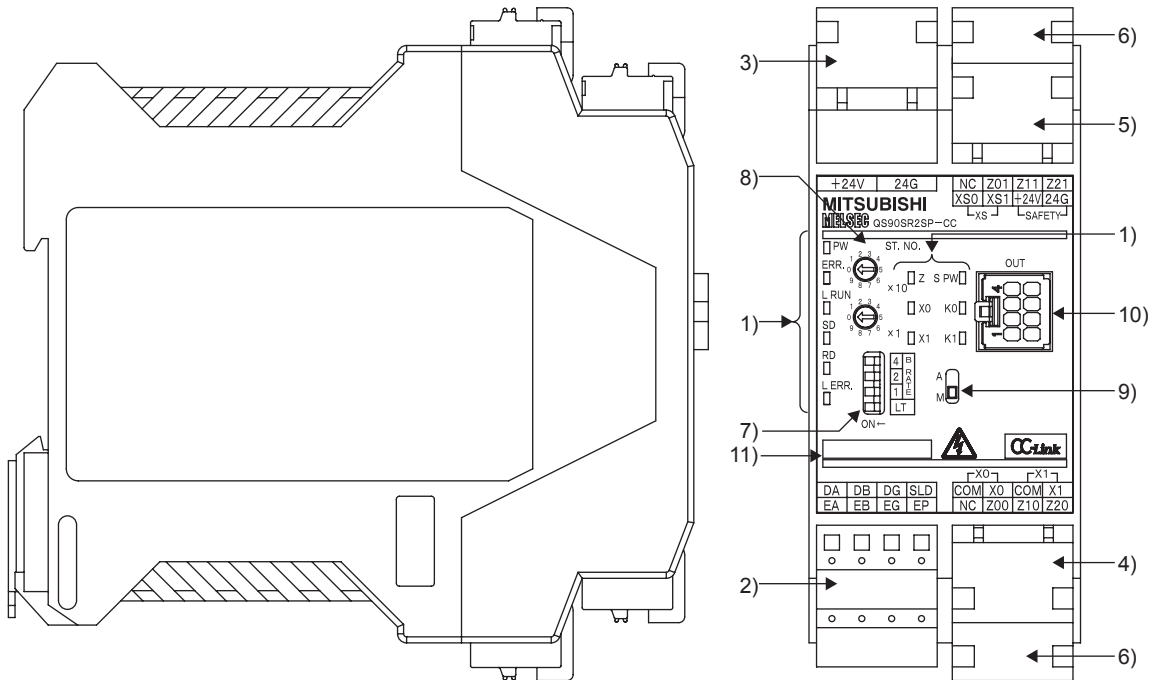

Figure 5.4 CC-Link safety relay module

Table 5.2 Part names (1/2)

Number	Name	Description
1)	Indicator LED	PW ON: Module power supply is supplied. OFF: Module power supply is cut off or powered OFF with electric fuse.
		ERR. ON: Indicates a failure in the monitor function of a module or an error in communications with the extension module. OFF: Normal
		L RUN ON: Normal communication OFF: Communication is cut off (time over error).
		SD ON: During data transmission
		RD ON: During data reception
		L ERR. ON: Indicates a communication error in the CC-Link system. Flashing regularly: A value set with station number setting switch or transmission speed setting switch is out of range. Flashing irregularly: The station number setting switch or transmission speed setting switch is changed during operation. OFF: A terminating resistor is not attached, is attached wrongly or is influenced by noise. OFF: Normal communication
		S PW ON: Indicates communication status of safety part power supply. OFF: Safety part power supply is cut off or powered OFF with electric fuse.

5 SETTINGS AND PROCEDURES BEFORE OPERATION

Table 5.2 Part names (1/2)

Number	Name	Description																																	
1)	Indicator LED	Z Indicates status of safety output Z. ON: Safety output is generated (both K0 and K1 are ON). OFF: Safety output is not generated.																																	
		X0 Indicates status of safety input (X0, X1). ON: Safety output is generated. OFF: Safety output is not generated.																																	
		X1 Indicates status of safety input (X0, X1). ON: Safety output is generated. OFF: Safety output is not generated.																																	
		K0 Indicates operating status of the internal safety relay K0 (coil status of K0). ON: Operating status of the internal safety relay K0 is ON. OFF: Operating status of the internal safety relay K0 is OFF.																																	
		K1 Indicates operating status of the internal safety relay K1 (coil status of K1). ON: Operating status of the internal safety relay K1 is ON. OFF: Operating status of the internal safety relay K1 is OFF.																																	
2)	CC-Link part, extension communication part terminal block	DA, DB, DG: Data terminal for CC-Link cable SLD: Shielding wire terminal of CC-Link cable EA, EB, EG: Data terminal for extension communication EP: Power supply terminal for extension module																																	
3)	Module power supply part terminal block	+ 24V: Module power supply + 24V terminal 24G: Module power supply 24G terminal																																	
4)	Safety input part terminal block	X0, X1 X0: Safety input X0 input terminal COM: Safety input X0 COM terminal X1: Safety input X1 input terminal COM: Safety input X1 COM terminal																																	
5)	Safety power supply, start-up part terminal block	XS XS0, XS1: Start-up off check terminal + 24V: Safety power supply + 24V terminal 24G: Safety power supply 24G terminal																																	
6)	Safety output part terminal block	Z00, Z01: Safety relay output terminal Z10, Z11: Safety relay output terminal Z20, Z21: Safety relay output terminal																																	
7)	CC-Link transmission speed terminating resistor setting switch	1 to 4 A switch for setting transmission speed of the CC-Link system and if terminating resistor is attached to the CC-Link system or not •Transmission speed setting (Switch number from 1 to 3) <table border="1" style="margin: 10px auto;"> <thead> <tr> <th rowspan="2">Setting</th> <th colspan="3">Setting switch status (B RATE)</th> <th rowspan="2">Transmission speed</th> </tr> <tr> <th>4</th> <th>2</th> <th>1</th> </tr> </thead> <tbody> <tr> <td>0</td> <td>OFF</td> <td>OFF</td> <td>OFF</td> <td>156kbps</td> </tr> <tr> <td>1</td> <td>OFF</td> <td>OFF</td> <td>ON</td> <td>625kbps</td> </tr> <tr> <td>2</td> <td>OFF</td> <td>ON</td> <td>OFF</td> <td>2.5Mbps</td> </tr> <tr> <td>3</td> <td>OFF</td> <td>ON</td> <td>ON</td> <td>5Mbps</td> </tr> <tr> <td>4</td> <td>ON</td> <td>OFF</td> <td>OFF</td> <td>10Mbps</td> </tr> </tbody> </table> Set the transmission speed within the range from 0 to 4. •Setting if CC-Link terminating resistor is attached or not (Switch number 4) Setting switch LT ON: Terminating resistor is attached. OFF: Terminating resistor is not attached.	Setting	Setting switch status (B RATE)			Transmission speed	4	2	1	0	OFF	OFF	OFF	156kbps	1	OFF	OFF	ON	625kbps	2	OFF	ON	OFF	2.5Mbps	3	OFF	ON	ON	5Mbps	4	ON	OFF	OFF	10Mbps
Setting	Setting switch status (B RATE)			Transmission speed																															
	4	2	1																																
0	OFF	OFF	OFF	156kbps																															
1	OFF	OFF	ON	625kbps																															
2	OFF	ON	OFF	2.5Mbps																															
3	OFF	ON	ON	5Mbps																															
4	ON	OFF	OFF	10Mbps																															
8)	CC-Link station number setting switch	STATION No. A switch for setting the station number of CC-Link system •Set tens place of the station number with " × 10" of "STATION No." •Set ones place of the station number with " × 1" of "STATION No." Set a station number within the range from 1 to 64. (Repeat use of a station number is not possible.)																																	
9)	Start-up mode setting switch	A switch for setting start-up mode "A" side: Auto mode "M" side: Manual mode																																	
10)	Safety part extension connector	OUT A connector for connecting an extension module																																	
11)	Serial number display	A serial number same as the one shown on the rating plate																																	

5.2.4 Station number setting

For station number setting in CC-Link system, refer to the User's Manual for the master/local module.

5.2.5 Module installation direction

The CC-Link safety relay module can be installed in five directions.

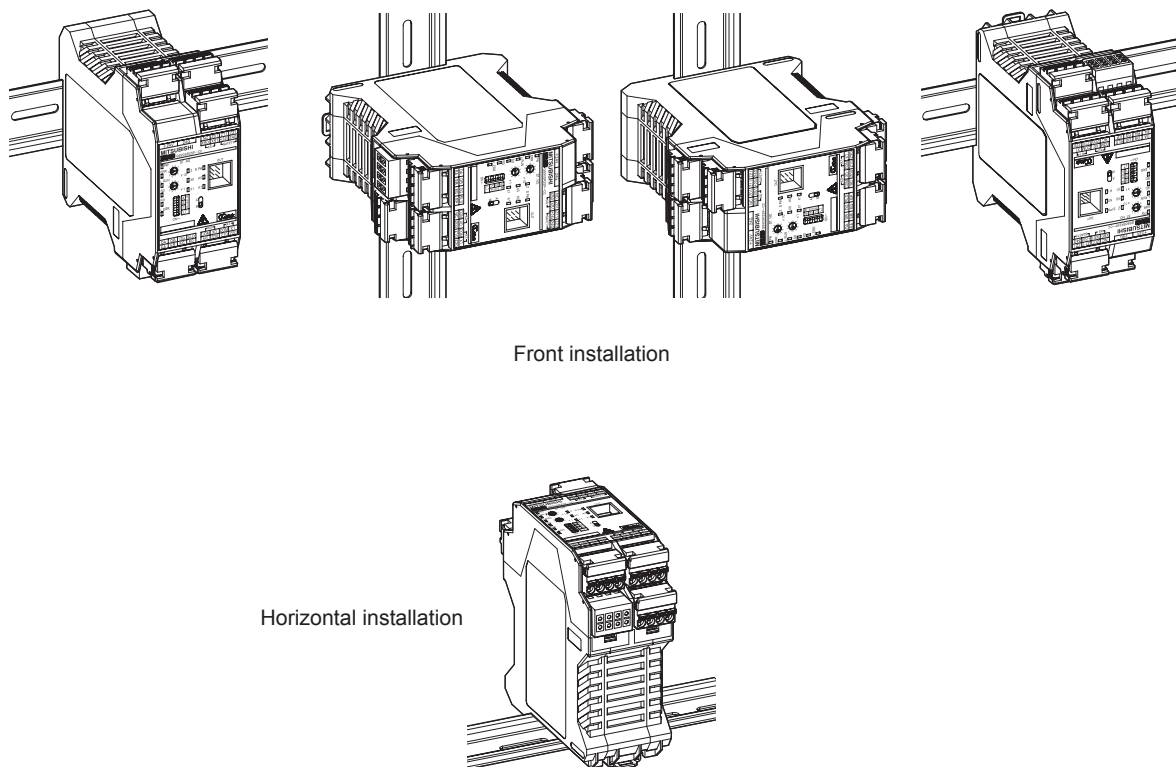

Figure 5.5 Module installation direction

5.3 Extension Safety Relay Module

5.3.1 Start-up procedures

Figure 5.6 shows start-up procedures for the extension safety relay module.

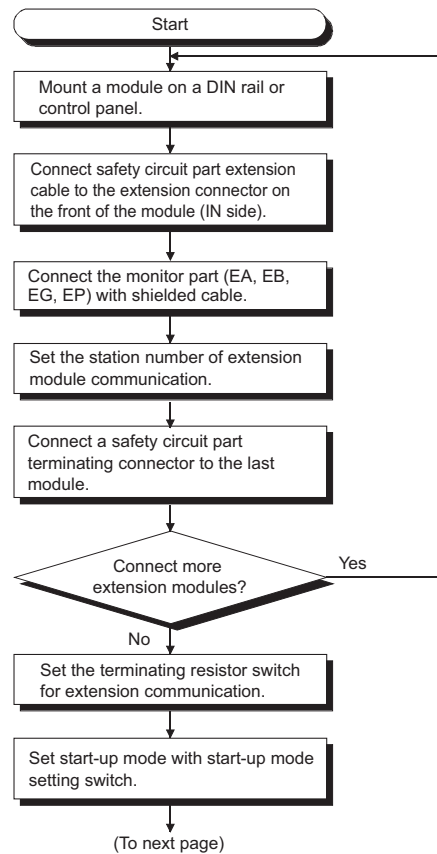

Figure 5.6 Start-up procedures (1/2)

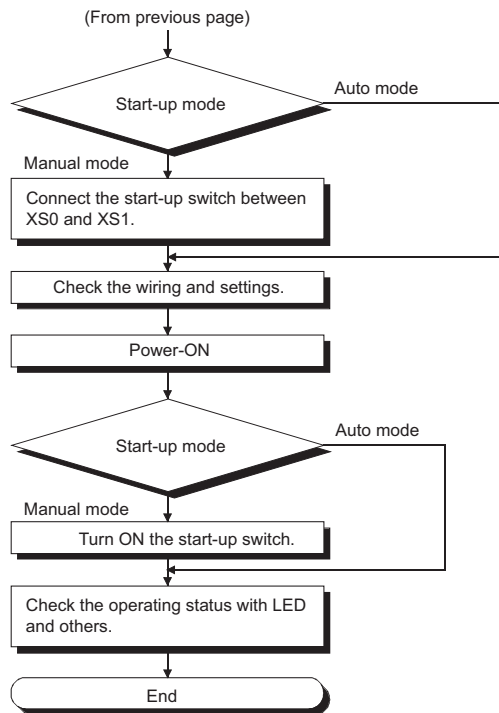

Figure 5.6 Start-up procedures (2/2)

POINT

When powering ON the system, make sure to power ON the safety power supply first, and then the module power supply.

If the module power supply is powered ON first, monitor signals cannot be read properly.

For details, refer to Section 6.3.

5.3.2 Handling precautions

This section explains handling precautions for the extension safety relay module.

 DANGER	<ul style="list-style-type: none">● Do not touch the terminals while power is on. Doing so could result in electric shock.● Turn off all phases of the external supply power used in the system when cleaning the module or retightening the terminal block mounting screws. Not doing so could result in electric shock. Tighten a terminal block mounting screw within the specified torque range. If the terminal block mounting screw is too loose, it may cause a short-circuit, fire or malfunctions. If too tight, it may damage the screw and/or the module, resulting in a drop of the screw or module, a short circuit or malfunctions.
---	--

 CAUTION	<ul style="list-style-type: none">● Be sure there are no foreign substances such as sawdust or wiring debris inside the module. Such debris could cause a fire, failure, or malfunctions.● Do not disassemble or remodel the module. Doing so could cause a failure, malfunctions, injury, or fire. If the product is repaired or remodeled by other than the specified FA centers or us, the warranty is not covered.● Do not directly touch the module's conductive parts or electronic components. Doing so may cause malfunctions or a failure.● When disposing of this product, treat it as industrial waste.
---	---

(1) Mounting DIN rail

When mounting a DIN rail, pay attention to the following:

- (a) Applicable DIN rail model (JIS C 2812 compliant)
 - TH35-7.5Fe
 - TH35-7.5Al
- (b) DIN rail mounting screw interval
 - Mount the DIN rail with screws at intervals of 200mm (7.87 inch) or less.
- (c) DIN rail fixing bracket
 - Securely fix a module with a DIN rail fixing bracket.

5.3.3 Part names and settings

This section explains each part name of the extension safety relay module.

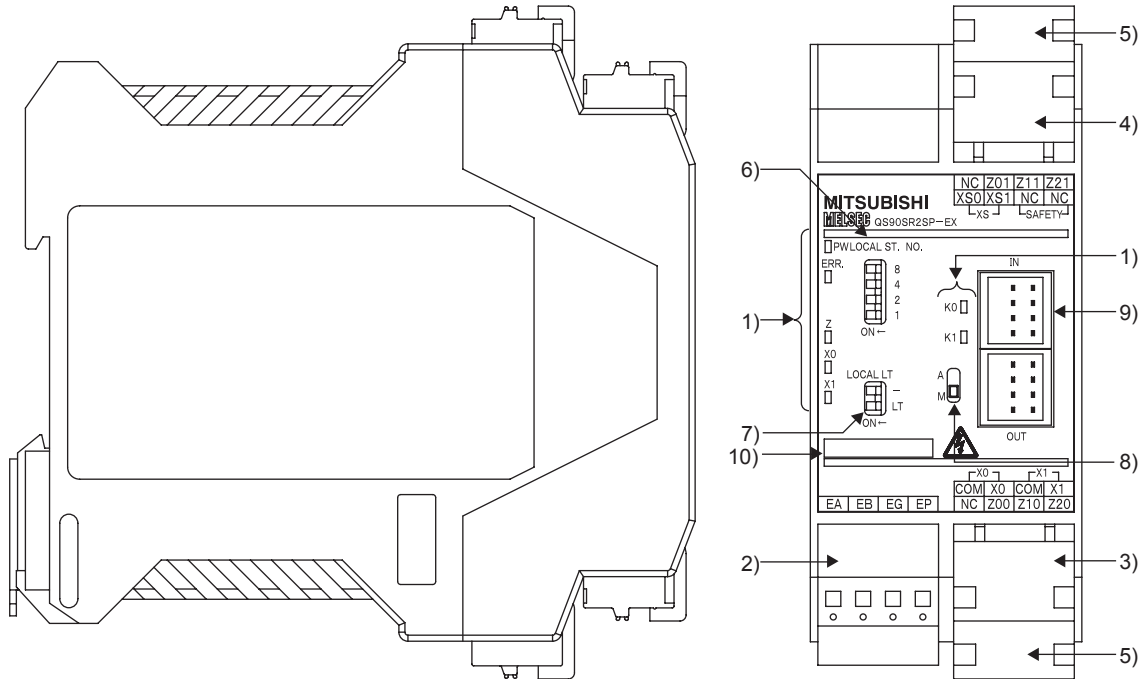

Figure 5.7 Extension safety relay module

Table 5.3 Part names (1/2)

Number	Name	Description
1)	Indicator LED	PW Indicates status of the module power supply. ON: Module power supply is supplied. OFF: Module power supply is cut off or powered OFF with electric fuse.
		ERR. Indicates a failure in the monitor function of a module or communication error in extension communication. ON: Communication error occurs in extension communication. OFF: Extension communication is normal.
		Z Indicates status of safety output Z. ON: Safety output is generated (both K0 and K1 are ON). OFF: Safety output is not generated.
		X0 Indicates status of safety input (X0, X1).
		X1 ON: Safety input is generated. OFF: Safety input is not generated.
		K0 Indicates operating status of the internal safety relay K0 (coil status of K0). ON: Operating status of the internal safety relay K0 is ON. OFF: Operating status of the internal safety relay K0 is OFF.
		K1 Indicates operating status of the internal safety relay K1 (coil status of K1). ON: Operating status of the internal safety relay K1 is ON. OFF: Operating status of the internal safety relay K1 is OFF.
2)	Extension communication part terminal block	EA, EB, EG: Data terminal for extension communication EP: Power supply terminal for extension module
3)	Safety input part terminal block	X0: Safety input X0 input terminal COM: Safety input X0 COM terminal X1: Safety input X1 input terminal COM: Safety input X1 COM terminal

5 SETTINGS AND PROCEDURES BEFORE OPERATION

Table 5.3 Part names (2/2)

Number	Name		Description																								
4)	Start-up part terminal block	XS	XS0, XS1: Start-up/off, check terminal																								
5)	Safety output part terminal block		Z00, Z01: Safety relay output terminal Z10, Z11: Safety relay output terminal Z20, Z21: Safety relay output terminal																								
6)	Extension communication station number setting switch	LOCAL ST No.	<p>A switch for setting the station number of extension communication</p> <table border="1"> <thead> <tr> <th rowspan="2">Setting</th> <th colspan="4">Setting switch status (LOCAL ST No.)</th> </tr> <tr> <th>8</th> <th>4</th> <th>2</th> <th>1</th> </tr> </thead> <tbody> <tr> <td>1</td> <td>OFF</td> <td>OFF</td> <td>OFF</td> <td>ON</td> </tr> <tr> <td>2</td> <td>OFF</td> <td>OFF</td> <td>ON</td> <td>OFF</td> </tr> <tr> <td>3</td> <td>OFF</td> <td>OFF</td> <td>ON</td> <td>ON</td> </tr> </tbody> </table> <p>Set a station number within the range from 1 to 3. Setting 4 or later may cause an error.</p>	Setting	Setting switch status (LOCAL ST No.)				8	4	2	1	1	OFF	OFF	OFF	ON	2	OFF	OFF	ON	OFF	3	OFF	OFF	ON	ON
Setting	Setting switch status (LOCAL ST No.)																										
	8	4	2	1																							
1	OFF	OFF	OFF	ON																							
2	OFF	OFF	ON	OFF																							
3	OFF	OFF	ON	ON																							
7)	Extension communication terminating resistor setting switch	LT	<p>Switch 1: Reserved Switch 2</p> <p>ON: Terminating resistor is attached. OFF: Terminating resistor is not attached.</p>																								
8)	Start-up mode setting switch		<p>A switch for setting start-up input mode</p> <p>"A" side: Auto mode "M" side: Manual mode</p>																								
9)	Safety part extension connector	IN, OUT	<p>A connector for connecting an extension module</p> <p>IN: A connector for connecting a module to the previous module with safety part extension cable at extension OUT: A connector for connecting a module to the next module with safety part extension cable at extension</p>																								
10)	Serial number display		A serial number same as the one shown on the rating plate																								

5.3.4 Module installation direction

The extension safety relay module can be installed in five directions.

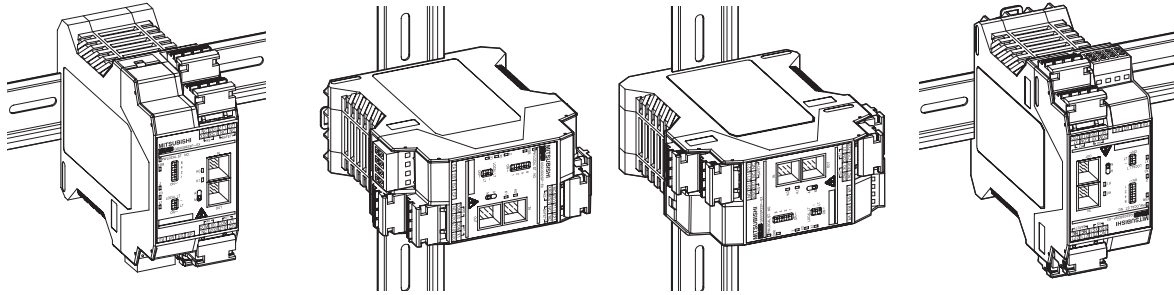

Front installation

Horizontal installation

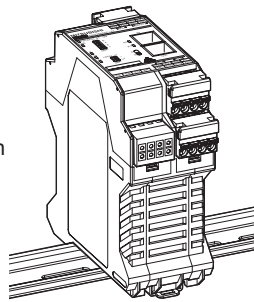

Figure 5.8 Module installation direction

5.4 Wiring

This section explains wiring of the safety relay module, power supply, and I/O module.

5.4.1 Precautions for safety devices and wiring

This section explains precautions for various safety devices and wiring.

(1) Safety input specifications

Table 5.4 shows specifications of safety inputs. Take care of safety device to be connected.

Wire the safety input so that the external wiring length can be 50m (164.04 feet) or less.

Table 5.4 Connectable safety devices

Module model	Terminal		Connectable device
QS90SR2SP-Q QS90SR2SP-CC QS90SR2SP-EX	X0	COM	Positive common
		X0	Input X0
	X1	COM	Positive common
		X1	Input X1
QS90SR2SN-Q QS90SR2SN-CC QS90SR2SN-EX	X0	COM	Positive common
		X0	Input X0
	X1	COM	Negative common
		X1	Input X1

* 1: Output devices which have built-in power supply and do not require external power supply from COM terminal, such as laser scanners, are included.

* 2: When connecting a light curtain to the QS90SR2SP-EX, refer to the precautions written under Section 5.4.1 (5).

(2) Output contact rating

Output contact rating is regulated to each category by IEC/EN954-1.

Use it with taking care of the following points.

Table 5.5 Output contact rating

Compliant category	Rated load	Remarks
Category 3 or less	5.0A	Rated load 250VAC 50/60Hz 30VDC
Category 4 *1	3.6A	EN60947-5-1 15AC 240VAC 2A $\cos\phi = 0.3$ 13DC 24VDC 1A L/R = 48ms*2

* 1: Even if Category 4 compliant system is configured, when the rated load exceeds 3.6A, the system becomes equivalent to Category 3 according to the standard.

* 2: The minimum application load is 24VDC/5mA (reference value).

(3) Protecting output contact

The output contact of a module does not include a fuse.

Externally connect protection fuse to prevent welding of output contact.

To meet the Category 4, use a fuse of 3.6A.

If short-circuit current is less than 5.0A, a fuse is unnecessary.

As measures against inductive load, protection such as using surge absorber to output contact is recommended.

(4) Electromagnetic switch for control

When using electromagnetic switch, it must be forcibly guided type and high reliable.

(5) Connecting a light curtain

(a) When connecting a light curtain to the main module (QS90SR2SP-Q, QS90SR2SP-CC), connect it to X0 and X1 sides as shown in Figure 5.9.

Connect light curtain power supply and safety part power supply by their ground side or supply power from the same power supply.

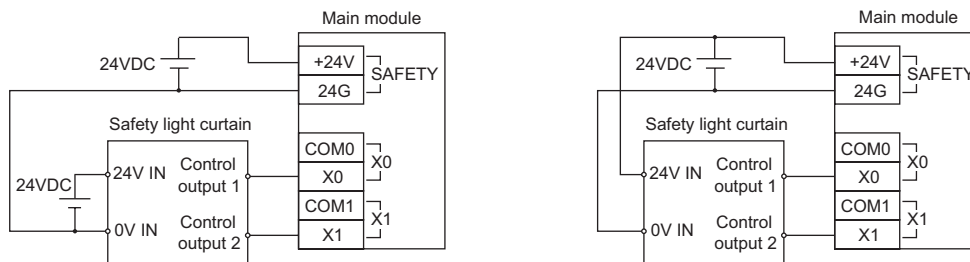

Figure 5.9 Connecting a light curtain to the main module

(b) When a light curtain is connected to the extension module (QS90SR2SP-EX), safety shutdown from the main module may be disabled depending on the wiring configuration.

Wire the cables referring to the connection diagram shown in Figure 5.10 and according to the precautions below.

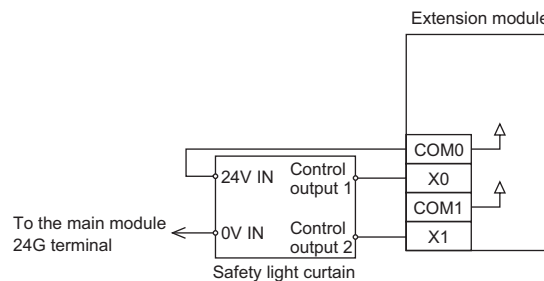

Figure 5.10 Connecting a light curtain to the extension module

Safety shutdown from the main module turns off inputs by cutting off input power supplied to the COM terminal of the extension module.

That is, if the wiring is configured so that power of the light curtain is supplied from the COM terminal of the extension module, power supply of the light curtain turns off and outputs of the extension module stops consequently in the event of the safety shutdown.

1) Precautions for selecting power supply

Power supply input of a light curtain will be connected to the COM terminal of the extension module. Select a light curtain compatible with the specifications for the COM terminal and X0/X1 terminals of the extension module.

Table 5.6 Specifications for selectable light curtains

Rated voltage	23 ± 10 [V]
Total amount of current consumption of light curtain (receiver) ^{*1}	One light curtain is connected: 420[mA] or less Two light curtains are connected: 340[mA] or less
ON voltage	20.0[V] or more
OFF voltage/current	2.4[V] or less/2.0[mA] or less

* 1: Current consumption = COM terminal output current (500[mA]) - ((X0 terminal input current (40[mA]) + X1 terminal input current (40[mA])) × Number of light curtains

The number of light curtains means the number of light curtains connected in one system. One system means the system configured with one main module and one or more extension module(s).

Specifications for the COM terminal of the extension module

Rated voltage : 23 ± 10% [V]
Output current : Maximum 500[mA]

Specifications for the X0 and X1 terminals of the extension module

ON voltage : 20.0[V] or more
OFF voltage/current : 2.4[V] or less/2.0[mA] or less
Input current : Maximum 40[mA]
Input voltage : Maximum 26.4[V]

2) Precautions for selecting power supply

Power of a light curtain is supplied from power supply connected between +24V(SAFETY) and 24G(SAFETY) of the main module via the COM terminal of the extension module. If the current or voltage supplied from the COM terminal is insufficient, operation of the light curtain cannot be guaranteed. Select the power supply device which meets the following conditions.

Power supply output voltage : 24 ± 10% [V]

Power supply output current : Main module current consumption (85[mA]) + (Extension module current consumption (80[mA]) × Number of extension modules) + (Total amount of current consumption of light curtain^{*2}) + ((X0 terminal input current (40[mA]) + X1 terminal input current (40[mA])) × Number of light curtains)[mA] or more

* 2: Control output current is not included. If included, subtract the control output current amount.

[Calculation example]

A calculation example for the system with three extension modules and two light curtains is shown below.

In the example, current consumption of each light curtain is assumed as follows.

Current consumption of light curtain A (receiver): 120[mA]

Current consumption of light curtain B (receiver): 210[mA]

Safety relay module specifications

Main module current consumption: 85[mA]

Extension module current consumption: 80[mA]

X0/X1 terminal input current: 40[mA]

$$\text{Power supply output current[mA]} > 85[\text{mA}] + (80[\text{mA}] \times 3) + (120[\text{mA}] + 210[\text{mA}]) + ((40[\text{mA}] + 40[\text{mA}]) \times 2)$$

$$\text{Power supply output current[mA]} > 815[\text{mA}]$$

As a result of the calculation, it is concluded that power supply which has output current 815[mA] or more is required for the system configuration in the above example.

(c) Precautions for connecting a light curtain

When connecting a light curtain referring to the connection diagram shown in Figure 5.10, pay attention to the following.

- 1) Light curtains cannot be connected to the main module and the extension module respectively at the same. Only a switch^{*1} such as an emergency stop can be connected as safety input of the main module.
- 2) Up to three extension modules can be connected to one main module. In this case, however, up to two extension modules are available for connecting a light curtain (one light curtain per module).
For the third extension module, only a switch^{*1} such as an emergency stop can be connected.
- 3) Power supply of a light curtain is cut off by turning on (opening the contact of) the switch which is connected to the input X0 and X1 of the main module. Check the time required for the light curtain to restart in the specification and provide an interlock until the restart of the light curtain is completed.
- 4) When connecting a switch to the X0 and X1 terminals of the main module, wire the cables so that the cable length becomes within 10m for both between the X0 and COM terminals and between the X1 and COM terminals.

* 1: Switch means a device whose condition between the COM terminal and X0 or X1 terminal is short-circuited when the switch is off (the contact is closed) and that has no load to develop voltage drop in the closed circuit.

(d) Time chart

Figure 5.11 shows the operation timing of each device when safety shutdown is executed by the main unit in the system where a light curtain is connected to the extension module.

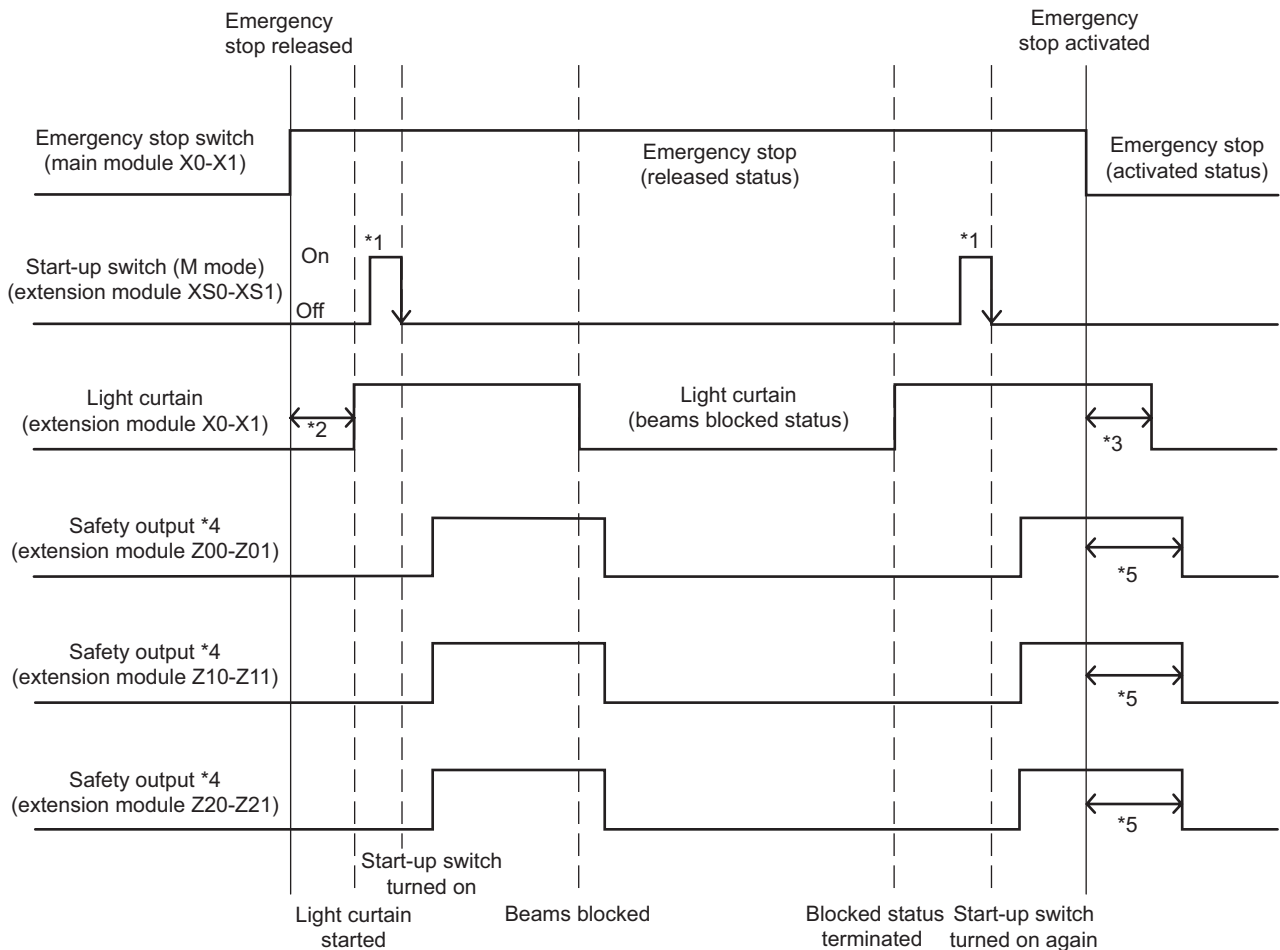

Figure 5.11 Operation time chart when a light curtain is connected

- * 1: Confirm that the light curtain has started, and then turn on the start-up switch of the extension module.
- * 2: Light curtain start-up time differs depending on the type of the light curtain.
- * 3: Light curtain stop time differs depending on the type of the light curtain.
- * 4: As for safety output response time, time until output on is 50ms or less and time until output off is 20ms or less.
For details, refer to Section 3.4.
- * 5: Safety outputs are turned off after the light curtain stops. Configure the system considering the time described at *3 and *4.

(6) Safety devices to be connected

Connect safety devices that meet the conditions as shown below.

(a) Push button switch for emergency stop

The switch that has the direct opening action (positive opening mechanism) and complies with EN60947-5-1 or IEC60947-5-1.

(b) Door interlock switch

The switch that has the direct opening action (positive opening mechanism) and complies with EN60947-5-1 or IEC60947-5-1.

(c) Light curtain/beam sensor switch

The switch that has reliable performance so that it can satisfy the required control category.

The input P type of the safety relay module does not have the channel-to-channel short-circuit diagnostics function for light curtain. Therefore, when using a light curtain and making it complied with Category 4, it must be Type 4 of IEC/ EN61496-1.

(7) Connecting safety devices

The same safety device cannot be input to multiple modules.

Also, start-up input cannot be input to multiple input modules.

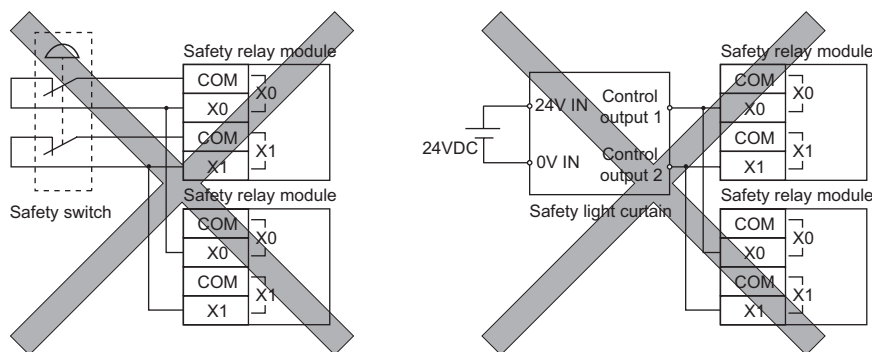

Figure 5.12 Connecting safety devices

(8) Safety stop and function stop

When using safety relay module, ON/OFF operation is made with the function stop according to control target. In this case, use it together with safety stop. Since only function stop may not stop the system, not doing so may cause a malfunction.

Connect safety devices to X0 and X1 sides and cut off the output on control target side.

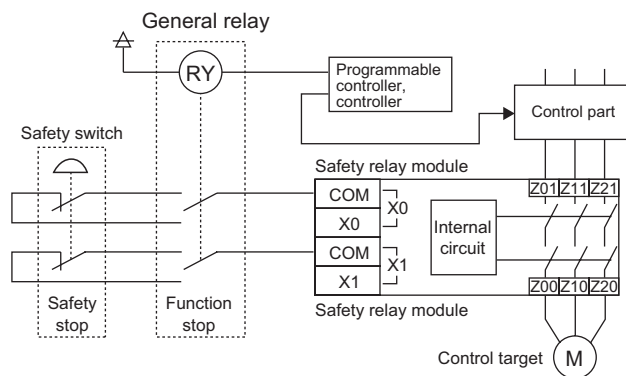

Figure 5.13 Safety stop and function stop

5.4.2 Spring clamp terminal block

(1) Method for connecting a cable to the spring clamp terminal block

(a) Connecting a cable

- 1) For module power supply part/safety power supply part/safety input part/safety output part terminal block

While pressing the open/close button with a flathead screwdriver, insert a cable into the insertion hole.

For use of bar terminals, the cable can be inserted without pressing the open/close button.

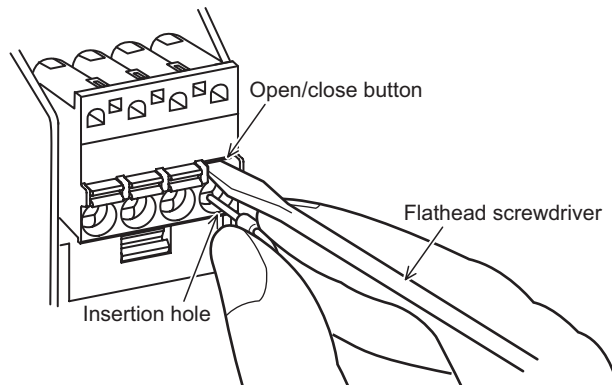

Figure 5.14 Connecting a cable to module power supply/safety power supply part/safety input part/safety output part terminal block

- 2) For extension communication part terminal block

Insert a flathead screwdriver into a ditch between the insertion holes, and insert a cable into the hole while pressing the driver.

For use of bar terminals, the cable can be inserted without pressing the open/close button.

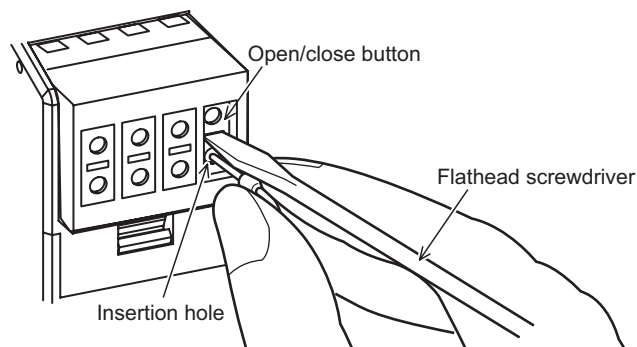

Figure 5.15 Connecting a cable to extension communication part terminal block

(b) Disconnecting a cable

- 1) For module power supply part/safety power supply part/safety input part/safety output part terminal block
While fully pressing the open/close button with a flathead screwdriver, pull out the cable.
- 2) For extension communication part terminal block
While fully pressing the ditch between the insertion holes with a flathead screwdriver, pull out the cable.

(2) Method for processing the cable end

The cable strip length must be around 10mm (0.39 inch).

If the cable is stripped too much, conductive part may stick out of the terminal block, which leads to electric shock or short-circuit between adjacent terminal blocks.

If the stripped length is too short, sufficient contact may not be ensured.

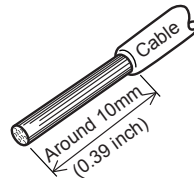

Figure 5.16 Cable strip length

For use of bar terminals, pay attention to the following:

- 1) Select a bar terminal suitable for the cable size.
- 2) Use an appropriate crimp tool to crimp the bar terminal.
- 3) Insert the cable so that cable cores will stick out by 0 to 0.5mm (0 to 0.02 inch) from the sleeve edge.

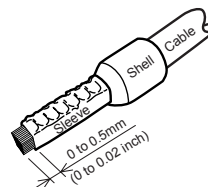

Figure 5.17 Bar terminal

- 4) Check an appearance of the bar terminal after crimping it. Do not use the terminal if it is not crimped properly or the side is damaged (refer to Figure 5.18).

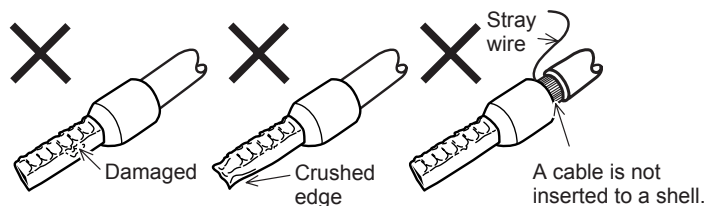

Figure 5.18 Example of incorrect bar terminal crimp

(3) Applicable terminals and crimp tools

Table 5.7 shows applicable solderless terminals (bar terminals) and applicable crimp tools.

Table 5.7 Applicable solderless terminals (bar terminals) and crimp tools

Product	Model	Maker	Remarks
Bar type solderless terminal	FA-VTC125T9	Mitsubishi Electric Engineering Co.,Ltd.	For CC-Link dedicated cables (0.3 to 1.65mm ²)
Tool for bar type solderless terminal	FA-NH65A		-
Bar type solderless terminal	TE0.5-10	NICHIFU Co., Ltd.	0.3 to 0.5mm ²
	TE0.75-10		0.75mm ²
	TE1.0-10		1.0mm ²
	TE1.5-10		1.5mm ²
	TE2.5-12		2.5mm ² *2
Tool for bar type solderless terminal	NH-79		-
Bar type solderless terminal	AI0.5-10WH	PHOENIX CONTACT	0.5mm ²
	AI0.75-10GY		0.75mm ²
	AI1-10RD		1.0mm ²
	AI1.5-10BK		1.5mm ²
	AI2.5-10BU		2.5mm ² *2
Tool for bar type solderless terminal	CRIMPFOX UD6		-
	CRIMPFOX UD6-4		*1
	CRIMPFOX UD6-6		*1
	CRIMPFOX ZA3		-

* 1: When shielding wires, power supply cables of 2 mm² (AWG #14) or FG wires are crimped to bar terminals using the CRIMPFOX UD6-4 or CRIMPFOX UD6-6, bar terminals may not be connected to the terminal block depending on the cross-sectional shape after crimping.

* 2: When power supply cables of 2.5mm² (maximum applicable wire size) or FG wires are crimped to bar terminals of 2.5 mm², bar terminals may not be connected to the terminal block.

5.4.3 Attaching/removing a terminal block

(1) Attaching a terminal block

- (a) For Q series safety relay module
Insert a terminal block into the connector and tighten terminal block fixing screws with a flathead screwdriver.
- (b) For CC-Link safety relay module and extension safety relay module
Fully insert the terminal block to the connector.
As for module power supply part/safety power supply part/safety input part/safety output part terminal block, close the terminal block cover after the insertion.
The terminal block cover cannot be closed if the terminal block is not fully inserted.

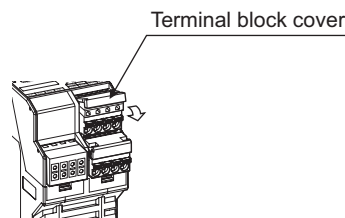

Figure 5.19 Terminal block cover

(2) Removing a terminal block

- (a) For Q series safety relay module
Loose the terminal block fixing screws with a flathead screwdriver, and pull out the terminal block.
- (b) For CC-Link safety relay module and extension safety relay module
As for module power supply part/safety power supply part/safety input part/safety output part terminal block, open the terminal block cover before pulling out the terminal block with a flathead screwdriver.

5.4.4 Precautions for handling CC-Link dedicated cable

This section explains precautions for handling the CC-Link dedicated cable. Do not handle the cable in the following manner. Doing so may damage the cable.

- Squashing it with sharp tool
- Twisting it excessively
- Pulling it strongly (exceeding the allowable tensility)
- Treading it
- Placing an object on it
- Scratching a cable jacket

5.4.5 Connecting with CC-Link dedicated cables

Figure 5.20 shows how safety relay modules are connected with CC-Link dedicated cables.

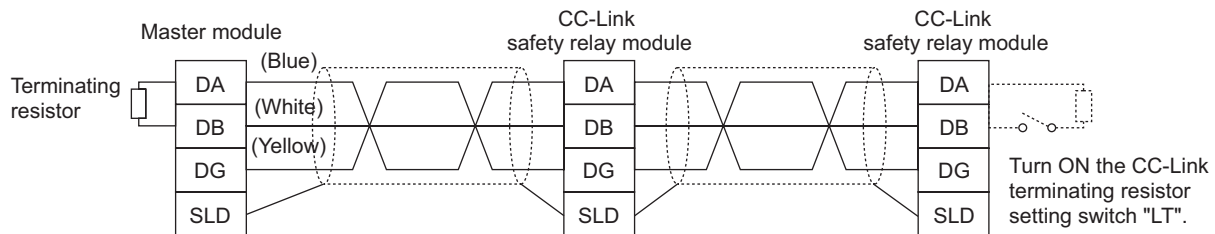

Figure 5.20 Connecting with CC-Link dedicated cables

POINT

- (1) Connect the shielded wire of the CC-Link dedicated cable to SLD terminals of each module, and ground the both ends to the protective ground conductor via FG terminals.
The SLD and FG terminals are connected inside the module.
- (2) Always connect terminating resistor to both ends of the module on data link.
Connect terminating resistor between DA and DB terminals.

5.4.6 Precautions for wiring power supply

When wiring to the power supply of safety relay module, take care of the following points.

- Cable length of the module power supply must be within 10m (32.81 feet) or less.
- The power supply to be connected to the safety relay module must meet the following conditions.
 - 1) The switching power supply complies with the EMC Directive, EN50178, EN60950-1 standard, and NEC CLASS2.
 - 2) SELV (Safety Extra Low Voltage): Reinforced insulation from hazardous potential area (48V or more) is provided.
 - 3) The power supply complies with the LVD Directive.
 - 4) The output voltage specification value is from 20.4 to 26.4VDC (ripple ratio within 5%).
- Use respective power supply for the module power supply and the safety power supply in order to obtain safety approval.
- Operating voltage range may differ for each module. Be careful with that when sharing the power supply with other Q/QS series modules.

5.4.7 Connecting extension modules

(1) Adding the safety part

- Add a safety relay module of same input type.
- Addition in combination with input P type module and input N type module is not possible.
- For addition of the safety part, use safety circuit part extension cable shown on Section 3.2.
If using another cable, the operation is not guaranteed.
- Connect safety part terminating connector attached to the main module to "OUT" connector on the extension module on the last stage.
If unconnected, the module does not operate.

(2) Adding the monitor part

Use shielded cable to add the monitor part and ground the shield.
Not doing so may cause a malfunction due to noise.

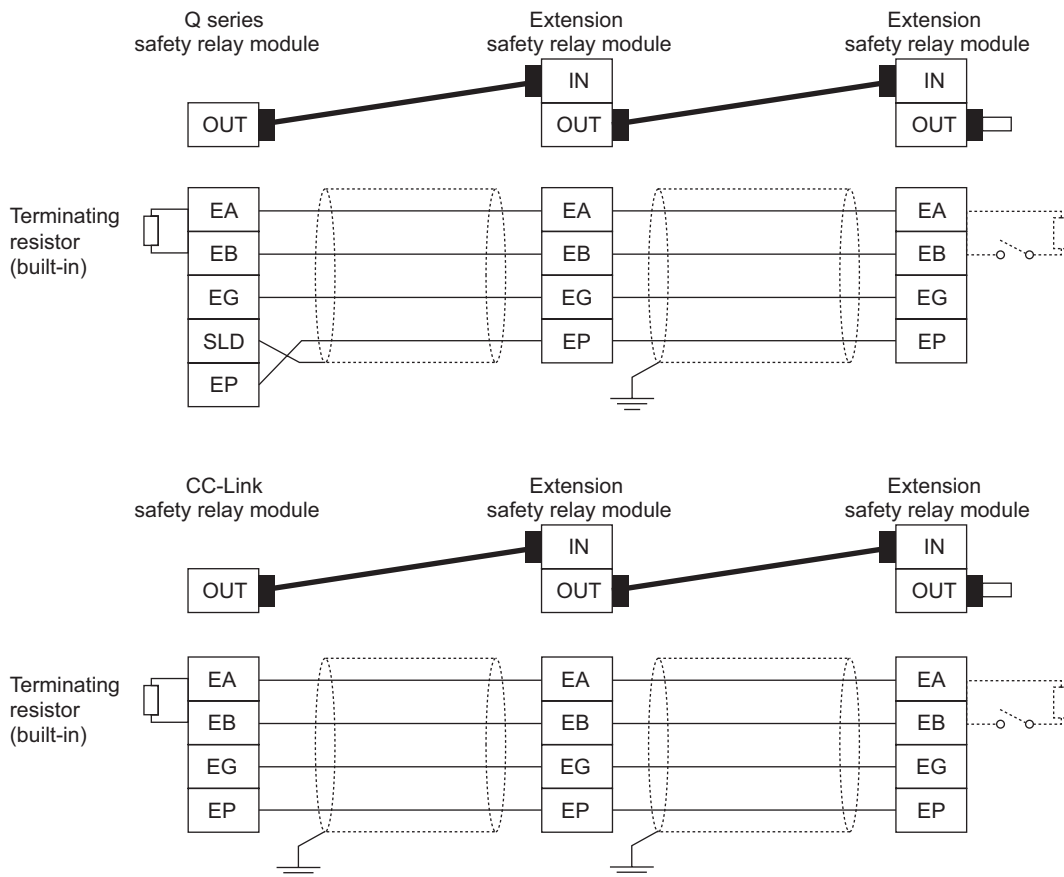

Figure 5.21 Connecting extension modules

CHAPTER6 TROUBLESHOOTING

This chapter explains description, cause investigation, and corrective action of an error when using the safety relay module.

To increase system reliability, starting the system early in the case of a failure is important as well as using the highly-reliable devices.

The following is the basic three points that should be noted when performing troubleshooting to find a failure cause, take corrective action against it, and start the system early.

(1) Visual check

Check the following points.

- 1) Machine status (stop status, operating status)
- 2) Status of safety relay module power supplies
- 3) External device status
- 4) Module mounting status
- 5) Wiring status (safety input line, power supply cable, CC-Link dedicated cable, extension cable)
- 6) Indication status of various indicators (POW, PW, ERR., K0, K1, Z, X0, X1, L RUN, SD, RD, L ERR.)
- 7) Setting status of various setting switches

After checking from 1) to 7), monitor PLC diagnostics, module operating status, or program contents with GX Developer.

(2) Failure check

An failure is divided into two categories as shown below.

(a) Safety-related failure

- 1) Whether the safety input is ON
- 2) Whether the safety input does not change at start-up
- 3) Whether the external device connected to off check remains OFF until start-up
- 4) Whether K0 and K1 LEDs are both OFF before start-up

(b) Monitor-related failure

Check how a failure changes by the following operations.

- 1) Switch the RUN/STOP/RESET switch on the programmable controller to "STOP".
- 2) Switch the RUN/STOP/RESET switch on the programmable controller to "RESET".
- 3) Power ON/OFF the monitor sides of the safety relay module and programmable controller.

(3) Narrowing down the trouble cause

Guess the failure location to any of the following by checking (1) and (2) above.

- 1) Safety relay module or external device?
- 2) Main module, extension module or another module?
- 3) Programmable controller?
- 4) Sequence program?

6.1 Q Series Safety Relay Module

6.1.1 Error check method with LED

Table 6.1 shows description, cause investigation, and corrective action of errors depending on LED display on the module.

Table 6.1 Error handling of safety part with LED

LED signal								Cause	Corrective action	
PW	S PW	ERR.	Z	K1	K0	X1	X0			
●	●	○	○	○	○	○	○	Main module	Normal	A display when the module does not start
●	●	○	●	●	●	●	●	Main module	Normal	A display when the module starts
*	○	*	*	*	*	*	*	The safety part power supply is not normally supplied.		<ul style="list-style-type: none"> •Check if the power supply is normally supplied. •Check between the power supplies for short. •In case of input N type, check between the dual inputs for short.
○	*	○	○	*	*	○	○	The module power supply is not normally supplied.		<ul style="list-style-type: none"> •Check if the power supply is normally supplied. •Check between the power supplies for short.
●	●	○	●	○	○	○	○	Contact welding of K0 and K1 relays	•Replace the module.	
●	●	○	○	○	○	●	●	K0 and K1 relays do not turn ON.*1		
●	●	○	○	*	*	●	○	Safety system 1 does not turn ON.*1		
●	●	○	○	*	*	○	●	Safety system 2 does not turn ON.*1		
●	●	○	○	○	●	○	●	Safety system 1 does not turn OFF.*1		
●	●	○	○	●	○	●	○	Safety system 2 does not turn OFF.*1		
*	*	●	*	*	*	*	*	<ul style="list-style-type: none"> •System error occurred. •No power supply on safety side •Extension module communication has not established. •Extension module is disconnected. 		<ul style="list-style-type: none"> •Check if the power supply is normally supplied. •Check between the power supplies for short. •Check if the extension module is normally connected.

●: ON, ○: OFF, *: ON or OFF

* 1: The status that start-up processing has been performed to the module

6.1.2 Error check method with monitor signal

Table 6.2 shows description, cause investigation, and corrective action of errors depending on monitor signal.

Table 6.2 Error handling of safety part with monitor signal

I/O port								Cause	Corrective action	
X7	X6	X5	X4	X3	X2	X1	X0			
Monitor signal										
K1RB	K0RB	K1	K0	XS	Z	X1	X0			
○	○	○	○	*	*	*	*	Main module	Normal	A display when the module does not start
●	●	●	●	*	●	●	●	Main module	Normal	A display when the module starts
○	●	○	○	*	○	*	*	Contact welding of K0 relay		•Replace the module.
●	○	○	○	*	○	*	*	Contact welding of K1 relay		
●	●	○	○	*	●	*	*	Contact welding of K0 and K1 relays		
●	○	●	●	*	○	●	●	K0 relay does not turn ON. (Due to a failure on the coil side)		
○	●	●	●	*	○	●	●	K1 relay does not turn ON. (Due to a failure on the coil side)		
○	○	●	●	*	○	●	●	K0 and K1 relays do not turn ON. (Due to a failure on the coil side)		
○	○	○	○	○	○	*	*	At auto mode Off check does not turn ON.		
○	○	○	○	●	○	*	*	At manual mode Off check does not turn OFF.		<ul style="list-style-type: none"> •Check if the wiring between start-up inputs are normal. •Check if the connected start-up switch operates normally and the wiring is normal. •Check if setting of the start-up mode is correct.
●	○	●	○	●	○	●	●	Safety system 1 does not turn ON.		•Replace the module.
○	●	○	●	●	○	●	●	Safety system 2 does not turn ON.		
○	●	○	●	●	○	○	○	Safety system 1 does not turn OFF.		
●	○	●	○	●	○	○	○	Safety system 2 does not turn OFF.		
○	○	○	○	*	○	○	●	The safety input is incorrect.		•Check if the input device connected to the safety input operates normally and the wiring is normal.
○	○	○	○	*	○	●	○			
●	●	○	○	○	●	○	○	The safety power supply has not been powered ON.		Power ON the safety power supply.

●: ON, ○: OFF, *: ON or OFF

POINT

If the safety power supply has not been powered ON, monitor signals that indicate normal module operation are not displayed. (The fixed pattern shown in Table 6.2 is displayed.)

Check errors with monitor signals after powering ON the safety power supply.

6.2 CC-Link Safety Relay Module

6.2.1 Error check method with LED

Table 6.3 shows description, cause investigation, and corrective action of errors depending on LED display on the module.

Table 6.3 Error handling of safety part with LED

LED signal								Cause	Corrective action	
PW	S PW	ERR.	Z	K1	K0	X1	X0			
●	●	○	○	○	○	○	○	Main module	Normal	A display when the module does not start
●	●	○	●	●	●	●	●	Main module	Normal	A display when the module starts
*	○	*	*	*	*	*	*	The safety part power supply is not normally supplied.		<ul style="list-style-type: none"> •Check if the power supply is normally supplied. •Check between the power supplies for short. •In case of input N type, check between the dual inputs for short.
○	*	○	○	*	*	○	○	The module power supply is not normally supplied.		<ul style="list-style-type: none"> •Check if the power supply is normally supplied. •Check between the power supplies for short.
●	●	○	●	○	○	○	○	Contact welding of K0 and K1 relays	•Replace the module.	
●	●	○	○	○	○	●	●	K0 and K1 relays do not turn ON.*1		
●	●	○	○	●	○	●	●	Contact welding of K0 and K1 relays	•Replace the module.	
●	●	○	○	○	●	●	●	K0 and K1 relays do not turn ON.*1		
●	●	○	○	○	●	○	○	Safety system 1 does not turn OFF.*1		
●	●	○	○	●	○	○	○	Safety system 2 does not turn OFF.*1		
*	*	●	*	*	*	*	*	<ul style="list-style-type: none"> •System error occurred. •No power supply on safety side •Extension module communication has not established. •Extension module is disconnected. 		<ul style="list-style-type: none"> •Check if the power supply is normally supplied. •Check between the power supplies for short. •Check if the extension module is normally connected.

●: ON, ○: OFF, *: ON or OFF

* 1: The status that start-up processing has been performed to the module

POINT

When L ERR. LED turns ON or is flashing, it indicates that an error occurred in the CC-Link system.

For troubleshooting of the CC-Link system, refer to the following manual.

CC-Link System Compact Type Remote I/O Module User's Manual

6.2.2 Error check method with monitor signal

Table 6.4 shows description, cause investigation, and corrective action of errors depending on monitor signal.

Table 6.4 Error handling of safety part with monitor signal

I/O port								Cause	Corrective action	
RX7	RX6	RX5	RX4	RX3	RX2	RX1	RX0			
Monitor signal										
K1RB	K0RB	K1	K0	XS	Z	X1	X0			
○	○	○	○	*	*	*	*	Main module	Normal	A display when the module does not start
●	●	●	●	*	●	●	●	Main module	Normal	A display when the module starts
○	●	○	○	*	○	*	*	Contact welding of K0 relay		•Replace the module.
●	○	○	○	*	○	*	*	Contact welding of K1 relay		
●	●	○	○	*	●	*	*	Contact welding of K0 and K1 relays		
●	○	●	●	*	○	●	●	K0 relay does not turn ON. (Due to a failure on the coil side)		
○	●	●	●	*	○	●	●	K1 relay does not turn ON. (Due to a failure on the coil side)		
○	○	●	●	*	○	●	●	K0 and K1 relays do not turn ON. (Due to a failure on the coil side)		
○	○	○	○	○	○	*	*	At auto mode Off check does not turn ON.		
○	○	○	○	●	○	*	*	At manual mode Off check does not turn OFF.		•Check if the wiring between start-up inputs are normal. •Check if the connected start-up switch operates normally and the wiring is normal. •Check if setting of the start-up mode is correct.
●	○	●	○	●	○	●	●	Safety system 1 does not turn ON.		•Replace the module.
○	●	○	●	●	○	●	●	Safety system 2 does not turn ON.		
○	●	○	●	●	○	○	○	Safety system 1 does not turn OFF.		
●	○	●	○	●	○	○	○	Safety system 2 does not turn OFF.		
○	○	○	○	*	○	○	●	The safety input is incorrect.		•Check if the input device connected to the safety input operates normally and the wiring is normal.
○	○	○	○	*	○	●	○			
●	●	○	○	○	●	○	○	The safety power supply has not been powered ON.		Power ON the safety power supply.

●: ON, ○: OFF, *: ON or OFF

POINT

If the safety power supply has not been powered ON, monitor signals that indicate normal module operation are not displayed. (The fixed pattern shown in Table 6.4 is displayed.)

Check errors with monitor signals after powering ON the safety power supply.

6.3 Extension Safety Relay Module

6.3.1 Error check method with LED

Table 6.5 shows description, cause investigation, and corrective action of errors depending on LED display on the module.

Table 6.5 Error handling of safety part with LED

LED signal							Cause	Corrective action	
PW	ERR.	Z	K1	K0	X1	X0			
●	○	○	○	○	○	○	Extension module	Normal	A display when the module does not start
●	○	●	●	●	●	●	Main module	Normal	A display when the module starts
○	○	○	*	*	○	○	The module power supply is not normally supplied.		<ul style="list-style-type: none"> •Check if the power supply is normally supplied. •Check between the power supplies for short. •In case of input N type, check between the dual inputs for short.
●	○	●	○	○	○	○	Contact welding of K0 and K1 relays	•Replace the module.	
●	○	○	○	○	●	●	K0 and K1 relays do not turn ON.* ¹		
●	○	○	●	○	●	●	Safety system 1 does not turn ON.* ¹		
●	○	○	○	●	●	●	Safety system 2 does not turn ON.* ¹		
●	○	○	○	●	○	○	Safety system 1 does not turn OFF.* ¹		
●	○	○	●	○	○	○	Safety system 2 does not turn OFF.* ¹		
*	*	●	*	*	*	*	<ul style="list-style-type: none"> •System error occurred. •No power supply on safety side 		<ul style="list-style-type: none"> •Check if the power supply is normally supplied. •Check between the power supplies for short.

●: ON, ○: OFF, *: ON or OFF

* 1: The status that start-up processing has been performed to the module

6.3.2 Error check method with monitor signal

Table 6.6 shows description, cause investigation, and corrective action of errors depending on monitor signal.

Table 6.6 Error handling of safety part with monitor signal

I/O port								Cause	Corrective action	
X7	X6	X5	X4	X3	X2	X1	X0			
Monitor signal										
K1RB	K0RB	K1	K0	XS	Z	X1	X0			
○	○	○	○	*	○	*	*	Main module	Normal	A display when the module does not start
●	●	●	●	*	●	●	●	Main module	Normal	A display when the module starts
○	●	○	○	*	○	*	*	Contact welding of K0 relay		•Replace the module.
●	○	○	○	*	○	*	*	Contact welding of K1 relay		
●	●	○	○	*	●	*	*	Contact welding of K0 and K1 relays		
●	○	●	●	*	○	●	●	K0 relay does not turn ON. (Due to a failure on the coil side)		
○	●	●	●	*	○	●	●	K1 relay does not turn ON. (Due to a failure on the coil side)		
○	○	●	●	*	○	●	●	K0 and K1 relays do not turn ON. (Due to a failure on the coil side)		
○	○	○	○	○	○	*	*	At auto mode Off check does not turn ON.		
○	○	○	○	●	○	*	*	At manual mode Off check does not turn OFF.		<ul style="list-style-type: none"> •Check if the wiring between start-up inputs are normal. •Check if the connected start-up switch operates normally and the wiring is normal. •Check if setting of the start-up mode is correct.
●	○	●	○	●	○	●	●	Safety system 1 does not turn ON.		•Replace the module.
○	●	○	●	●	○	●	●	Safety system 2 does not turn ON.		
○	●	○	●	●	○	○	○	Safety system 1 does not turn OFF.		
●	○	●	○	●	○	○	○	Safety system 2 does not turn OFF.		
○	○	○	○	*	○	○	●	The safety input is incorrect.		•Check if the input device connected to the safety input operates normally and the wiring is normal.
○	○	○	○	*	○	●	○			
●	●	○	○	○	●	○	○	The safety power supply has not been powered ON.		Power ON the safety power supply.

●: ON, ○: OFF, *: ON or OFF

POINT

If the safety power supply has not been powered ON, monitor signals that indicate normal module operation are not displayed. (The fixed pattern shown in Table 6.6 is displayed.)

Check errors with monitor signals after powering ON the safety power supply.

APPENDIX

Appendix 1 External Dimensions

Appendix 1.1 Q series safety relay module

(1) QS90SR2SP-Q, QS90SR2SN-Q

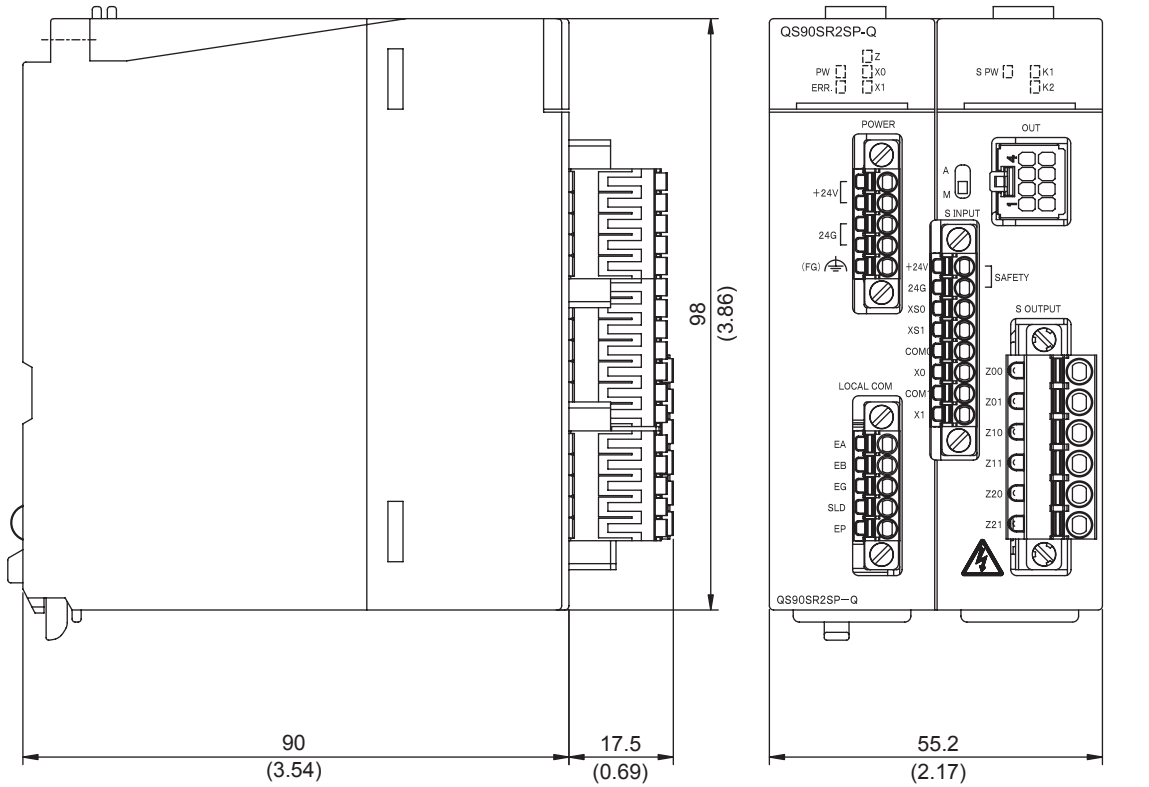

Unit: mm (inch)

Figure App.1 QS90SR2SP-Q, QS90SR2SN-Q

1

OVERVIEW

2

SYSTEM CONFIGURATION

3

SPECIFICATIONS

4

FUNCTIONS

5

SETTINGS AND PROCEDURES BEFORE OPERATION

6

TROUBLESHOOTING

APPENDIX

Appendix 1.3 Extension safety relay module

(1) QS90SR2SP-EX, QS90SR2SN-EX

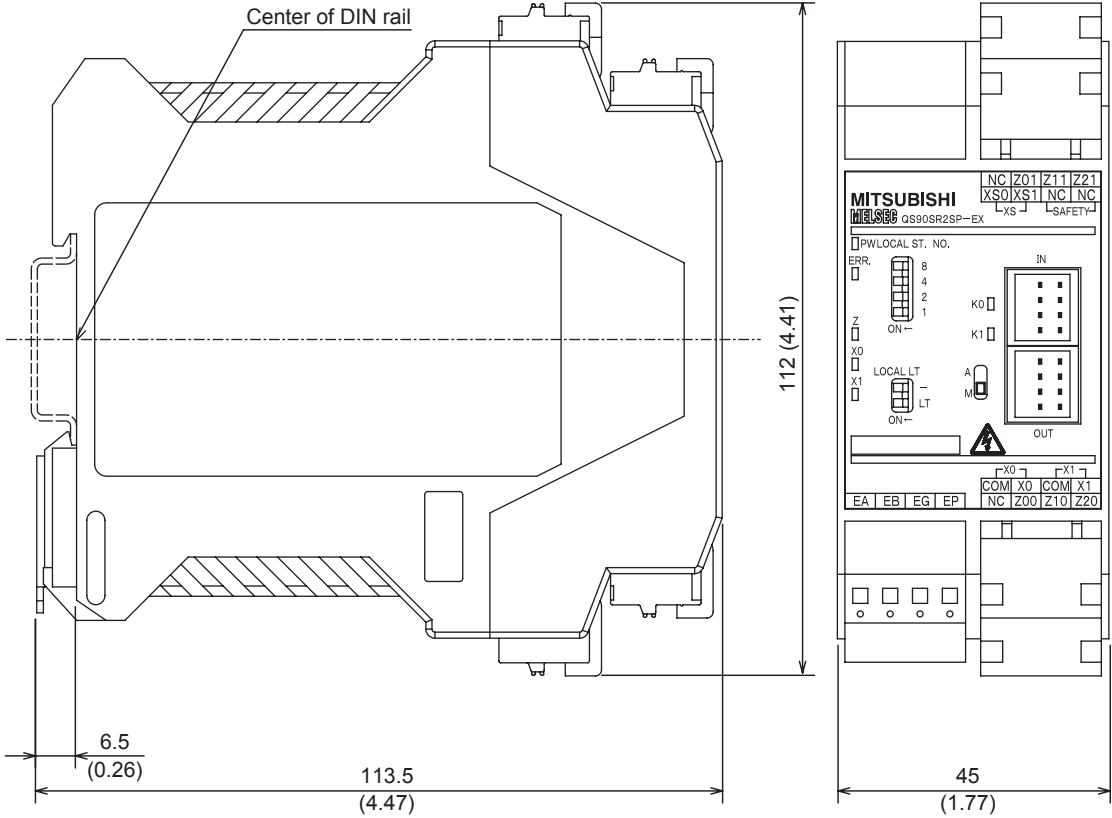

Unit: mm (inch)

Figure App.3 QS90SR2SP-EX, QS90SR2SN-EX

1 OVERVIEW

2 SYSTEM CONFIGURATION

3 SPECIFICATIONS

4 FUNCTIONS

5 SETTINGS AND PROCEDURES BEFORE OPERATION

6 TROUBLESHOOTING

APPENDIX

WARRANTY

Please confirm the following product warranty details before using this product.

1. Limited Warranty and Product Support.

- a. Mitsubishi Electric Company ("MELCO") warrants that for a period of eighteen (18) months after date of delivery from the point of manufacture or one year from date of Customer's purchase, whichever is less, Mitsubishi Safety relay module (the "Products") will be free from defects in material and workmanship.
- b. At MELCO's option, for those Products MELCO determines are not as warranted, MELCO shall either repair or replace them or issue a credit or return the purchase price paid for them.
- c. For this warranty to apply:
 - (1) Customer shall give MELCO (i) notice of a warranty claim to MELCO and the authorized dealer or distributor from whom the Products were purchased, (ii) the notice shall describe in reasonable details the warranty problem, (iii) the notice shall be provided promptly and in no event later than thirty (30) days after the Customer knows or has reason to believe that Products are not as warranted, and (iv) in any event, the notice must be given within the warranty period;
 - (2) Customer shall cooperate with MELCO and MELCO's representatives in MELCO's investigation of the warranty claim, including preserving evidence of the claim and its causes, meaningfully responding to MELCO's questions and investigation of the problem, grant MELCO access to witnesses, personnel, documents, physical evidence and records concerning the warranty problem, and allow MELCO to examine and test the Products in question offsite or at the premises where they are installed or used; and
 - (3) If MELCO requests, Customer shall remove Products it claims are defective and ship them to MELCO or MELCO's authorized representative for examination and, if found defective, for repair or replacement. The costs of removal, shipment to and from MELCO's designated examination point, and reinstallation of repaired or replaced Products shall be at Customer's expense.
 - (4) If Customer requests and MELCO agrees to effect repairs onsite at any domestic or overseas location, the Customer will pay for the costs of sending repair personnel and shipping parts. MELCO is not responsible for any re-commissioning, maintenance, or testing on-site that involves repairs or replacing of the Products.
- d. Repairs of Products located outside of Japan are accepted by MELCO's local authorized service facility centers ("FA Centers"). Terms and conditions on which each FA Center offers repair services for Products that are out of warranty or not covered by MELCO's limited warranty may vary.
- e. Subject to availability of spare parts, MELCO will offer Product repair services for (7) years after each Product model or line is discontinued, at MELCO's or its FA Centers' rates and charges and standard terms in effect at the time of repair. MELCO usually produces and retains sufficient spare parts for repairs of its Products for a period of seven (7) years after production is discontinued.
- f. MELCO generally announces discontinuation of Products through MELCO's Technical Bulletins. Products discontinued and repair parts for them may not be available after their production is discontinued.

2. Limits of Warranties.

- a. MELCO does not warrant or guarantee the design, specify, manufacture, construction or installation of the materials, construction criteria, functionality, use, properties or other characteristics of the equipment, systems, or production lines into which the Products may be incorporated, including any safety, fail-safe and shut down systems using the Products.
- b. MELCO is not responsible for determining the suitability of the Products for their intended purpose and use, including determining if the Products provide appropriate safety margins and redundancies for the applications, equipment or systems into which they are incorporated.
- c. Customer acknowledges that qualified and experienced personnel are required to determine the suitability, application, design, construction and proper installation and integration of the Products. MELCO does not supply such personnel.
- d. MELCO is not responsible for designing and conducting tests to determine that the Product functions appropriately and meets application standards and requirements as installed or incorporated into the end-user's equipment, production lines or systems.
- e. MELCO does not warrant any Product:
 - (1) repaired or altered by persons other than MELCO or its authorized engineers or FA Centers;
 - (2) subjected to negligence, carelessness, accident, misuse, or damage;
 - (3) improperly stored, handled, installed or maintained;
 - (4) integrated or used in connection with improperly designed, incompatible or defective hardware or software;
 - (5) that fails because consumable parts such as relay, batteries, backlights, or fuses were not tested, serviced or replaced;
 - (6) operated or used with equipment, production lines or systems that do not meet applicable and commensurate legal, safety and industry-accepted standards;
 - (7) operated or used in abnormal applications;
 - (8) installed, operated or used in contravention of instructions, precautions or warnings contained in MELCO's user, instruction and/or safety manuals, technical bulletins and guidelines for the Products;
 - (9) used with obsolete technologies or technologies not fully tested and widely accepted and in use at the time of the Product's manufacture;
 - (10) subjected to excessive heat or moisture, abnormal voltages, shock, excessive vibration, physical damage or other improper environment; or
 - (11) damaged or malfunctioning due to Acts of God, fires, acts of vandals, criminals or terrorists, communication or power failures, or any other cause or failure that results from circumstances beyond MELCO's control.
- f. All Product information and specifications contained on MELCO's website and in catalogs, manuals, or technical information materials provided by MELCO are subject to change without prior notice.

- g. The Product information and statements contained on MELCO's website and in catalogs, manuals, technical bulletins or other materials provided by MELCO are provided as a guide for Customer's use. They do not constitute warranties and are not incorporated in the contract of sale for the Products.
- h. These terms and conditions constitute the entire agreement between Customer and MELCO with respect to warranties, remedies and damages and supersede any other understandings, whether written or oral, between the parties. Customer expressly acknowledges that any representations or statements made by MELCO or others concerning the Products outside these terms are not part of the basis of the bargain between the parties and are not factored into the pricing of the Products.
- i. THE WARRANTIES AND REMEDIES SET FORTH IN THESE TERMS ARE THE EXCLUSIVE AND ONLY WARRANTIES AND REMEDIES THAT APPLY TO THE PRODUCTS.
- j. MELCO DISCLAIMS THE IMPLIED WARRANTIES OF MERCHANTABILITY AND FITNESS FOR A PARTICULAR PURPOSE.

3. Limits on Damages.

- a. MELCO'S MAXIMUM CUMULATIVE LIABILITY BASED ON ANY CLAIMS FOR BREACH OF WARRANTY OR CONTRACT, NEGLIGENCE, STRICT TORT LIABILITY OR OTHER THEORIES OF RECOVERY REGARDING THE SALE, REPAIR, REPLACEMENT, DELIVERY, PERFORMANCE, CONDITION, SUITABILITY, COMPLIANCE, OR OTHER ASPECTS OF THE PRODUCTS OR THEIR SALE, INSTALLATION OR USE SHALL BE LIMITED TO THE PRICE PAID FOR PRODUCTS NOT AS WARRANTED.
- b. Although MELCO has obtained the certification for Product's compliance to the international safety standards EN954-1/ISO13849-1 from TUV Rheinland, this fact does not guarantee that Product will be free from any malfunction or failure. The user of this Product shall comply with any and all applicable safety standard, regulation or law and take appropriate safety measures for the system in which the Product is installed or used and shall take the second or third safety measures other than the Product. MELCO is not liable for damages that could have been prevented by compliance with any applicable safety standard, regulation or law.
- c. MELCO prohibits the use of Products with or in any application involving power plants, trains, railway systems, airplanes, airline operations, other transportation systems, amusement equipments, hospitals, medical care, dialysis and life support facilities or equipment, incineration and fuel devices, handling of nuclear or hazardous materials or chemicals, mining and drilling, and other applications where the level of risk to human life, health or property are elevated.
- d. MELCO SHALL NOT BE LIABLE FOR SPECIAL, INCIDENTAL, CONSEQUENTIAL, INDIRECT OR PUNITIVE DAMAGES, FOR LOSS OF PROFITS, SALES, OR REVENUE, FOR INCREASED LABOR OR OVERHEAD COSTS, FOR DOWNTIME OR LOSS OF PRODUCTION, FOR COST OVERRUNS, OR FOR ENVIRONMENTAL OR POLLUTION DAMAGES OR CLEAN-UP COSTS, WHETHER THE LOSS IS BASED ON CLAIMS FOR BREACH OF CONTRACT OR WARRANTY, VIOLATION OF STATUTE, NEGLIGENCE OR OTHER TORT, STRICT LIABILITY OR OTHERWISE.
- e. In the event that any damages which are asserted against MELCO arising out of or relating to the Products or defects in them, consist of personal injury, wrongful death and/or physical property damages as well as damages of a pecuniary nature, the disclaimers and limitations contained in these terms shall apply to all three types of damages to the fullest extent permitted by law. If, however, the personal injury, wrongful death and/or physical property damages cannot be disclaimed or limited by law or public policy to the extent provided by these terms, then in any such event the disclaimer of and limitations on pecuniary or economic consequential and incidental damages shall nevertheless be enforceable to the fullest extent allowed by law.
- f. In no event shall any cause of action arising out of breach of warranty or otherwise concerning the Products be brought by Customer more than one year after the cause of action accrues.
- g. Each of the limitations on remedies and damages set forth in these terms is separate and independently enforceable, notwithstanding the unenforceability or failure of essential purpose of any warranty, undertaking, damage limitation, other provision of these terms or other terms comprising the contract of sale between Customer and MELCO.

4. Delivery/Force Majeure.

- a. Any delivery date for the Products acknowledged by MELCO is an estimated and not a promised date. MELCO will make all reasonable efforts to meet the delivery schedule set forth in Customer's order or the purchase contract but shall not be liable for failure to do so.
- b. Products stored at the request of Customer or because Customer refuses or delays shipment shall be at the risk and expense of Customer.
- c. MELCO shall not be liable for any damage to or loss of the Products or any delay in or failure to deliver, service, repair or replace the Products arising from shortage of raw materials, failure of suppliers to make timely delivery, labor difficulties of any kind, earthquake, fire, windstorm, flood, theft, criminal or terrorist acts, war, embargoes, governmental acts or rulings, loss or damage or delays in carriage, acts of God, vandals or any other circumstances reasonably beyond MELCO's control.

5. Choice of Law/Jurisdiction.

These terms and any agreement or contract between Customer and MELCO shall be governed by the laws of the State of New York without regard to conflicts of laws. To the extent any action or dispute is not arbitrated, the parties consent to the exclusive jurisdiction and venue of the federal and state courts located in the Southern District of the State of New York. Any judgment there obtained may be enforced in any court of competent jurisdiction.

6. Arbitration.

Any controversy or claim arising out of, or relating to or in connection with the Products, their sale or use or these terms, shall be settled by arbitration conducted in accordance with the Center for Public Resources (CPR) Rules for Non-Administered Arbitration of International Disputes, by a sole arbitrator chosen from the CPR's panels of distinguished neutrals. Judgment upon the award rendered by the Arbitrator shall be final and binding and may be entered by any court having jurisdiction thereof. The place of the arbitration shall be New York City, New York. The language of the arbitration shall be English. The neutral organization designated to perform the functions specified in Rule 6 and Rules 7.7(b), 7.8 and 7.9 shall be the CPR.

Safety Relay Module User's Manual

MODEL	QS-SR-U-SY-E
MODEL CODE	13JY62
SH(NA)-080746ENG-C(0811)MEE	



HEAD OFFICE : TOKYO BUILDING, 2-7-3 MARUNOUCHI, CHIYODA-KU, TOKYO 100-8310, JAPAN
NAGOYA WORKS : 1-14, YADA-MINAMI 5-CHOME, HIGASHI-KU, NAGOYA, JAPAN

When exported from Japan, this manual does not require application to the
Ministry of Economy, Trade and Industry for service transaction permission.

Specifications subject to change without notice.