

MITSUBISHI

GT16 Multimedia Unit

User's Manual

GT16M-MMR

Thank you for purchasing the GOT1000 Series.

Prior to use, please read both this manual and detailed manual thoroughly to fully understand the product.

MODEL	GT16M-MMR-U
MODEL CODE	1D7M87
IB(NA)-0800432-A(0808)MEE	

GRAPHIC OPERATION TERMINAL
GOT1000

SAFETY PRECAUTIONS

(Always read these precautions before using this equipment.)

Before using this product, please read this manual and the relevant manuals introduced in this manual carefully and pay full attention to safety to handle the product correctly.

The precautions given in this manual are concerned with this product.

In this manual, the safety precautions are ranked as "DANGER" and "CAUTION".

DANGER Indicates that incorrect handling may cause hazardous conditions, resulting in death or severe injury.

CAUTION Indicates that incorrect handling may cause hazardous conditions, resulting in medium or slight personal injury or physical damage.

Note that the CAUTION level may lead to a serious accident according to the circumstances.

Always follow the precautions of both levels because they are important to personal safety.

Please save this manual to make it accessible when required and always forward it to the end user.

DESIGN PRECAUTIONS

CAUTION

- Do not bunch the control wires or communication cables with the main circuit or power wires, or lay them close to each other. As a guide, separate the lines by a distance of at least 100 mm (3.94 inch). Otherwise malfunctions may occur due to noise.

INSTALLATION PRECAUTIONS

DANGER

- Be sure to shut off all phases of the external power supply used by the system before mounting or removing this unit from the GOT. Not doing so can cause a unit failure or malfunction.
- Before connecting the Bus connection cable to this unit, always shut off GOT power and PLC CPU power externally in all phases. Not doing so can cause a malfunction.

CAUTION

- Use this unit in the environment given in the general specifications of the GT16 User's Manual. Not doing so can cause an electric shock, fire, malfunction or product damage or deterioration.
- Do not drop the unit or subject it to strong shock. A unit damage may result.
- When installing this unit to the GOT, fit it to the connection interface of the GOT and tighten the mounting screws in the specified torque range. Undertightening can cause a drop, failure or malfunction. Overtightening can cause a drop, failure or malfunction due to screw or unit damage.

WIRING PRECAUTIONS

DANGER

- Be sure to shut off all phases of the external power supply used by the system before wiring. Not doing so may result in an electric shock, product damage or malfunctions.

CAUTION

- Exercise care to avoid foreign matter such as chips and wire offcuts entering the unit. Not doing so can cause a fire, failure or malfunction.
- Make sure to securely connect the cable to the connector of unit. Incorrect connection may cause malfunctions.

STARTUP AND MAINTENANCE PRECAUTIONS

DANGER

- Before starting cleaning, always shut off GOT power externally in all phases. Not doing so can cause a unit failure or malfunction. Undertightening can cause the GOT to drop, short circuit or malfunction. Overtightening can cause a short circuit or malfunction due to the damage of the screws or unit.
- Do not disassemble or modify the unit and the CF card. Doing so can cause a failure, malfunction, injury or fire.
- Do not touch the conductive areas and electronic parts of this unit directly. Doing so can cause a unit malfunction or failure.

CAUTION

- Always secure the cables connected to the unit, e.g. run them in conduits or clamp them. Not doing so can cause unit or cable damage due to dangling, moved or accidentally pulled cables or can cause a malfunction due to a cable contact fault.
- Do not hold the cable part when unplugging any cable connected to the unit. Doing so can cause unit or cable damage or a malfunction due to a cable contact fault.
- Always make sure to touch the grounded metal to discharge the electricity charged in the body, etc., before touching the unit. Failure to do so may cause a failure or malfunctions of the unit.

CAUTION

- When installing a CF card into this unit, insert it into the card slot of this unit until the CF card eject button pops out. Failure to do so may cause a malfunction due to poor contact.
- Before inserting or removing a CF card into/from this unit, turn the CF card access switch off.
- Failure to do so may corrupt data on the CF card.
- When removing a CF card from the GOT, support it by hand, as it may pop out. Failure to do so may cause the CF card to drop from the unit, resulting in a damage or failure.

DISPOSAL PRECAUTIONS

CAUTION

- Dispose of this product as industrial waste.

TRANSPORTATION PRECAUTIONS

CAUTION

- Make sure to transport the GOT main unit and/or relevant unit(s) in the manner they will not be exposed to the impact exceeding the impact resistance described in the general specifications of the GT16 User's Manual, as they are precision devices. Failure to do so may cause the unit to fail. Check if the unit operates correctly after transportation.

Manuals

The following shows manuals relevant to this product.

Manual name	Manual number (Model code)
GT16 User's Manual (Sold separately)	SH-080778ENG (1D7M88)
GOT1000 Series Connection Manual (1/3 to 3/3) (Sold separately)	SH-080532ENG (1D7M26)
GT Designer2 Version2 Screen Design Manual (For GOT1000 Series) (1/3 to 3/3) (Sold separately)	SH-080530ENG (1D7M25)

Relevant Manuals

For relevant manuals, refer to the PDF manuals stored in the GT Designer2 CD-ROM.

© 2008 MITSUBISHI ELECTRIC CORPORATION

Packing List

After unpacking the box, check that the following products are included.

Model	Product	Quantity
GT16M-MMR	Multimedia unit	1
	Mounting screw set (4 screws, 4 stickers)	1
	Extension interface relay board	1
	Cable clamp (for sound I/O)	1

1. OVERVIEW

This User's Manual describes GT16 multimedia unit (hereinafter referred to as the multimedia unit).

The following functions are available by mounting the multimedia unit on the GT16 □ □ M.

- The GOT can display video images taken by a camcorder, or the video images can be stored as video files in a CF card and the video files can be played.
- When an error occurs, video images taken 120 seconds before and after the error (up to 240 seconds) can be stored as video files in a CF card.
- Ethernet connection, video files can be sent to the personal computer using the FTP server function.

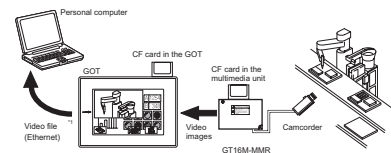

*1: To store video files in the personal computer, the FTP server function of the GOT and the multimedia interaction tool are required. To use the multimedia unit, set the communication settings. For the settings and system configurations, refer to GOT1000 Series Connection Manual. For the multimedia function, refer to GT Designer2 Version □ Screen Design Manual.

2. SPECIFICATIONS

The following shows the performance specifications of the multimedia unit. The general specifications of the multimedia unit are the same as those of the GOT.

For the general specifications of the GOT, refer to GT16 User's Manual.

Item	Specifications
Video input section	Color input format: NTSC format, PAL format (interlaced format)
	Monochrome input format: EIA format, CCIR format (interlaced format)
	Number of channels: 1 channel
	Video input signal: I/P-p, 75 Ω, composite signal
	Display size (dot): 640x480, 768x576 ¹
Sound input section ²	Connector for external connection: BNC connector
	Applicable wire size: 75 Ω shielded coaxial cable at shield cable
Sound output section ²	Number of channels: 1 channel
	Sound output signal: 1 Vrms (Rated load 10k Ω)
	Connector for external connection: φ3.5 stereo mini jack, straight type
CF Card I/F section	Slot: Compact flash Slot (TYPE1) 1 channel
	Mode: True-IDE mode
Ethernet I/F section ²	Number of channels: 1 channel
	Connector for external connection: RJ-45 jack
	Data transfer method: 10BASE-T/100BASE-TX
Video file	File format: 3GP, MP4
	Video coding/decoding format: MPEG-4 Part 2 SP@LV4
	Resolution/maximum frame rate: VGA/15fps, QVGA/30fps
	Resolution/maximum frame rate: VGA/15fps, QVGA/30fps
Internal current consumption	3.3VDC: 0.51A
	5.0VDC: 0.27A
Weight	0.28kg (0.61lb)

¹:Compatible with PAL, and CCIR formats only.
²:Supported soon.

3. PART NAMES AND EXTERNAL DIMENSIONS

3.1 Multimedia Unit

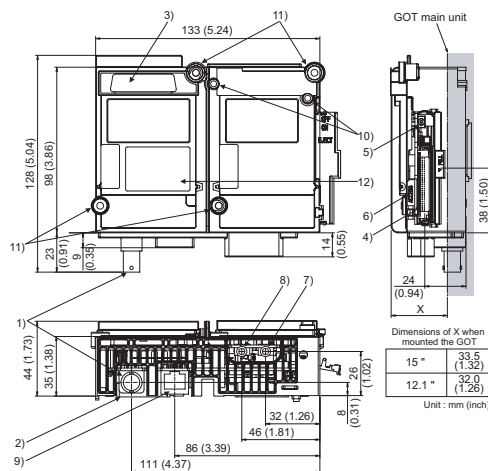

No.	Name	Description
1)	Connector for video input	Connector for connecting a coaxial cable
2)	Interface connector	Connector connected to the GOT
3)	Extension connector	Connector for connecting an extension unit
4)	Connector for video connection	Connector connected to the video interface of the GOT
5)	CF card interface	Interface for inserting a CF card
6)	CF card access switch	Switch for enabling or disabling access to the CF card ON: CF card accessed OFF: CF card not accessed
7)	CF card access LED	LED lamp lit when the CF card is accessed
8)	Sound input terminal	Terminal for connecting the cable of the sound input device
9)	Sound output terminal	Terminal for connecting the cable of the sound output device
10)	Ethernet connector	Connector for Ethernet communication
11)	Board fixing screw	Screw for fixing the extension interface relay board
12)	Mounting screw	Screw for fixing the multimedia unit
13)	Rating plate	-

3.2 Extension Interface Relay Board

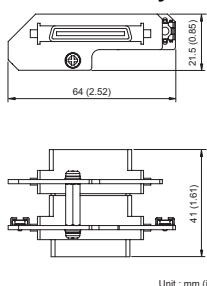

4. INSTALLATION PROCEDURE

4.1 Cable Connection

- Connect the cables of the sound I/O devices to the multimedia unit.
- Attach the cable clamp to the unit. Position the cable clamp band outside, and insert the cable clamp to section A shown in the following figure until it clicks. For the band inserting direction, refer to the arrow. (The cable clamp is the RST-1NB manufactured by TAKEUCHI INDUSTRY CO., LTD.)
- Put the cables of the sound I/O devices through the looped cable clamp band, and pull the band to fix the cables.

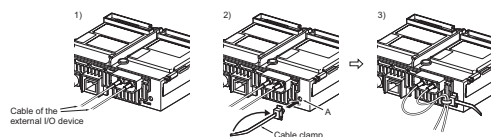

4.2 Unit Installation

- Turn off the GOT.
- Remove two extension unit covers of the GOT.
- Connect the extension interface relay board to the extend I/F-2 on the GOT. Remove the connector cover from the board.
- Fit the multimedia unit in the GOT case.

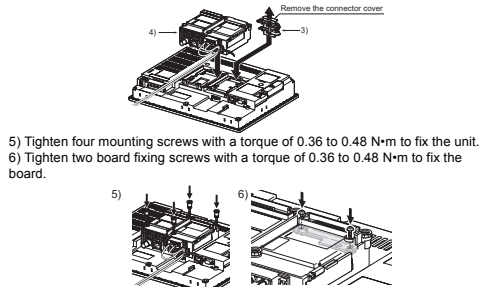

- Tighten four mounting screws with a torque of 0.36 to 0.48 N-m to fix the unit.
- Tighten two board fixing screws with a torque of 0.36 to 0.48 N-m to fix the board.
- For mounting any extension unit on the multimedia unit, remove the connector cover and the stickers. For mounting no extension unit on the multimedia unit, cover over four mounting screws with the accessory stickers to avoid static electricity. Keep the connector cover fixed. Keep all the stickers fixed.

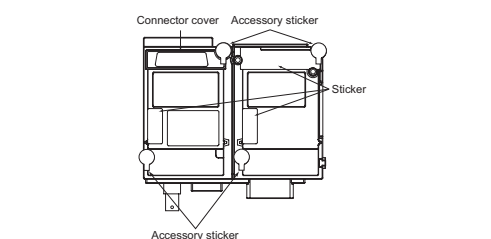

Point

Precautions for connecting sound I/O devices
Do not connect or disconnect the cables of the sound I/O sections during sound input or output.
Do not connect devices other than sound I/O devices to the sound I/O sections of the multimedia unit.

Removing multimedia unit
Remove the board fixing screws, and then remove the multimedia unit by tilting Δ PULL so that the connector is not damaged. (Refer to (6).)

- Removing cable clamp band
The cable clamp band can be removed after the cables are fixed. Press the tab of the cable clamp upward using a screwdriver and others, and pull out the band.
- Removing cables from multimedia unit
The cables of the sound I/O devices can be removed from the unit even if the cables are fixed with the cable clamp. Remove the cables by pressing the cable clamp from both directions (arrow A).

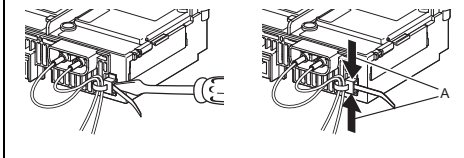

5. CF CARD INSTALLATION/REMOVAL PROCEDURE

5.1 Installation

- Open the CF card cover, and turn off the CF card access switch of the unit.

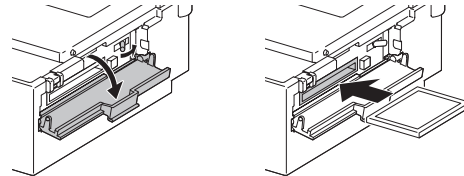

- Insert a CF card into the CF card interface with the front side facing up.
- Turn on the CF card access switch.

5.2 Removal

- Open the CF card cover.
Turn off the CF card access switch, and check that the CF card access LED turns off.
(When the CF card access LED is off, the CF card can be removed even while the GOT power is on.)

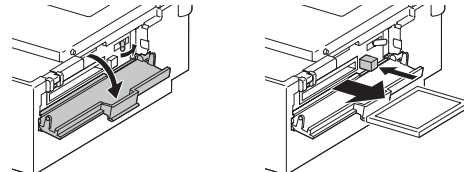

- Press the CF card eject button to pop out the CF card, and remove the card.

Warranty

Mitsubishi will not be held liable for damage caused by factors found not to be the cause of Mitsubishi; machine damage or lost profits caused by faults in the Mitsubishi products; damage, secondary damage, accident compensation caused by special factors unpredictable by Mitsubishi; damages to products other than Mitsubishi products; and other duties.

For safe use

- This product has been manufactured as a general-purpose part for general industries, and has not been designed or manufactured to be incorporated in a device or system used in purposes related to human life.
- Before using the product for special purposes such as nuclear power, electric power, aerospace, medicine or passenger movement vehicles, consult with Mitsubishi.
- This product has been manufactured under strict quality control. However, when installing the product where major accidents or losses could occur if the product fails, install appropriate backup or failsafe functions in the system.

Country/Region	Sales office/Tel
U.S.A.	Mitsubishi Electric Automation Inc. 500 Corporate Woods Parkway Vernon Hills, IL 60061, U.S.A. Tel : +1-847-478-2100
Brazil	MELCO-TEC Rep. Com.e Assessoria Tecnica Ltda. Rua Correa Dias, 184, Edificio Paraiso Trade Center-8 andar Paraiso, Sao Paulo, SP Brazil Tel : +55-11-5908-8331
Germany	Mitsubishi Electric Europe B.V. German Branch Goltner Strasse 8 D-40880 Ratingen, GERMANY Tel : +49-2102-486-0
U.K.	Mitsubishi Electric Europe B.V. UK Branch Travellers Lane, Hatfield, Hertfordshire., AL10 8XB, U.K. Tel : +44-1707-276100
Italy	Mitsubishi Electric Europe B.V. Italian Branch Centro Dir. Colleoni, Pal. Perseo-Ing.2 Via Paracelso 12, I-20041 Agrate Brianza., Milano, Italy Tel : +39-039-60531
Spain	Mitsubishi Electric Europe B.V. Spanish Branch Carretera de Ruda 176-80, E-08190 Sant Cugat del Valles, Barcelona, Spain Tel : +34-93-565-3131
France	Mitsubishi Electric Europe B.V. French Branch 25, Boulevard des Bouvets, F-92741 Nanterre Cedex, France TEL : +33-1-5588-5568
South Africa	Circuit Breaker Industries Ltd. Private Bag 2016, ZA-1600 Isando, South Africa Tel : +27-11-928-2000
Hong Kong	Mitsubishi Electric Automation (Hong Kong) Ltd. 10th Floor, Manulife Tower, 169 Electric Road, North Point, Hong Kong Tel : +852-2887-8870
China	Mitsubishi Electric Automation (Shanghai) Ltd. 4/F Zhi Fu Plaza, No.80 Xin Chang Road, Shanghai 200003, China Tel : +86-21-6120-0808
Taiwan	Settuyo Enterprise Co., Ltd. 6F No. 105 Wu-Kung 3rd.Rd., Wu-Ku Hsiang, Taipei Hsinai, Taiwan Tel : +886-2-2299-2499
Korea	Mitsubishi Electric Automation Korea Co., Ltd. 1480-8, Gayang-dong, Gangseo-ku Seoul 157-200, Korea Tel : +82-2-3660-9552
Singapore	Mitsubishi Electric Asia Pte, Ltd. 307 Alexandra Road #05-01/02, Mitsubishi Electric Building, Singapore 159943 Tel : +65-6470-2460
Thailand	Mitsubishi Electric Automation (Thailand) Co., Ltd. Bang-Chan Industrial Estate No.111 Moo 4, Santhai Rd, T.Karnayao, A.Kanmayao, Bangkok 10230 Thailand Tel : +66-2-517-1326
Indonesia	P.T. Autoteknindo Sumber Makmur Muara Karang Selatan, Block A/Utara No.1 Kav. No.11 Kawasan Industri Pergudangan Jakarta - Utara 14440, P.O.Box 5045 Jakarta, 11050 Indonesia Tel : +62-21-6630833
India	Messung Systems Pvt. Ltd. Electronic Sadan NO.III Unit No15, M.I.D.C Bhosari, Pune-411026, India Tel : +91-20-2712-3130
Australia	Mitsubishi Electric Australia Pty. Ltd. 348 Victoria Road, Rydalmere, N.S.W 2116, Australia Tel : +61-2-9684-7777

MITSUBISHI ELECTRIC CORPORATION
HEAD OFFICE: TOKYO BUILDING, 3-7-3 MARUNOUCHI, CHYODA-KU, TOKYO 100-8310, JAPAN
NAGOYA WORKS: 1-14, YADA-MINAMI 5-CHOME, HIGASHI-KU, NAGOYA, JAPAN

When exported from Japan, this manual does not require application to the Ministry of Economy, Trade and Industry for service transaction permission.

Specifications subject to change without notice.
Printed in Japan.