

MITSUBISHI

GT15 CF card unit
User's Manual

GT15-CFCD

Thank you for purchasing the GOT1000 Series.

Prior to use, please read both this manual and detailed manual thoroughly to fully understand the product.

MODEL	GT15-CFCD-U
MODEL CODE	1D7M62
IB(NA)-0800365-D(0811)MEE	

GRAPHIC OPERATION TERMINAL
GOT1000

SAFETY PRECAUTIONS

(Be sure to read these instructions before use.)

Before using this product, read this and relevant manuals carefully and handle the product correctly with full attention to safety. Note that these precautions apply only to this product. In this manual, SAFETY PRECAUTIONS are classified into 2 levels: "DANGER" and "CAUTION".

DANGER Indicates that incorrect handling may cause hazardous conditions, resulting in death or severe injury.

CAUTION Indicates that incorrect handling may cause hazardous conditions, resulting in medium or slight personal injury or physical damage.

Under some circumstances, failure to observe the CAUTION level instructions may also lead to serious accidents. Be sure to observe the instructions of both levels to ensure the safety. Please keep this manual in a safe place for future reference and also pass this manual on to the end user.

Installation precautions

DANGER

- Be sure to shut off all phases of the external power supply used by the system before mounting or removing this unit to/from the GOT. Not doing so can cause the unit to fail or malfunction.
- Be sure to shut off all phases of the external power supply of the GOT main unit before connecting the cable to this unit. Not doing so can cause the unit to fail or malfunction.

CAUTION

- Use this unit under the environment specified in GT16 User's Manual or GT15 User's Manual. Otherwise, it may cause electric shocks, fires, malfunctions, product deterioration or damage.
- When installing this unit, fit it to the connection interface of the GOT and tighten the mounting screws. If the screw is too loose, it may cause a drop of the unit, a failure or malfunctions. Tightening the screw excessively may damage the screw and/or the unit, resulting in a drop of the unit, a failure or malfunctions.
- When installing a CF card into this unit, insert it into the card slot of this unit until the CF card eject button pops out. Failure to do so may cause a malfunction due to poor contact.
- Before inserting or removing a CF card into/from this unit, turn the CF card access switch off. Failure to do so may corrupt data on the CF card.
- When removing a CF card from the GOT, support it by hand, as it may pop out. Failure to do so may cause the CF card to drop from the unit, resulting in a damage or failure.

Wiring precautions

DANGER

- Be sure to shut off all phases of the external power supply used by the system before wiring. Failure to do so may result in an electric shock, product damage or malfunctions.

CAUTION

- Carefully prevent foreign matter such as dust or wire chips from entering this unit. Failure to do so may cause a fire, failure or malfunctions.

Startup and maintenance precautions

DANGER

- Be sure to shut off all phases of the external power supply of the GOT main unit before starting cleaning. Not doing so can cause the unit to fail or malfunction.

CAUTION

- Do not disassemble or modify this unit and CF card. Doing so can cause failure, malfunctions, personal injuries and/or a fire.
- Do not touch the conductive and electronic parts of this unit directly. Doing so can cause a unit malfunction or failure.
- Do not drop or apply strong impact to this unit or the CF card. Doing so may damage the unit or CF card.
- Before handling this unit, touch a grounded metal object to discharge the static electricity from the human body. Failure to do so may cause failure or malfunctions of the unit.

Disposal precautions

CAUTION

- When disposing of the product, treat it as an industrial waste.

Transportation precautions

CAUTION

- Make sure to transport this unit in the manner it will not be exposed to the impact exceeding the impact resistance described in the general specifications of GT16 User's Manual or GT15 User's Manual, as it is a precision device. Failure to do so may cause the unit to fail. Check if the unit operates correctly after transportation.

MANUALS

The following shows manuals relevant to this product.

Manual name	Manual number (Model code)
GT16 User's Manual (Sold separately)	SH-080778ENG (1D7M88)
GT15 User's Manual (Sold separately)	SH-080528 (1D7M23)

Relevant Manuals

For relevant manuals, refer to the PDF manuals stored in the GT Designer2 CD-ROM.

© 2006 MITSUBISHI ELECTRIC CORPORATION

Compliance with the EMC and Low Voltage Directives

When incorporating the Mitsubishi GOT into other machinery or equipment and keeping compliance with the EMC and low voltage directives, refer to "EMC Directives and Low Voltage Directives" of GT15 User's Manual. The CE logo is printed on the rating plate of the GOT, indicating compliance with the EMC and low voltage directives.

Packing List

The following items are included.

Model name	Product name	Quantity
GT15-CFCD	CF card unit	1
	Screw set (2 screws)	1

3. PART NAMES AND EXTERNAL DIMENSIONS

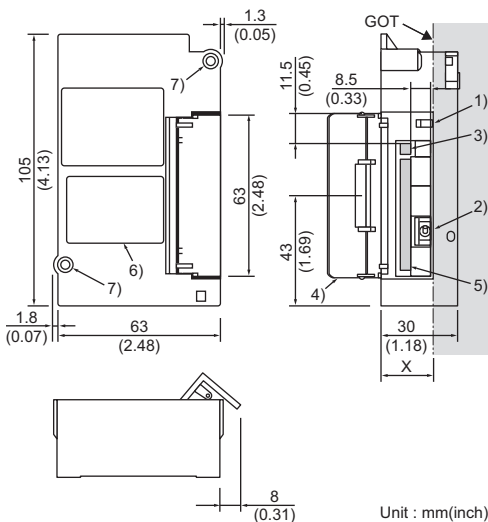

Dimensions of X when installing the unit on the GOT

	GOT	GT16	GT15
15"		18.5(0.73)	20(0.79)
12.1"		17(0.67)	17(0.67)
10.4"		-	20(0.79)
8.4", 5.7"		-	22(0.87)

Unit: mm(inch)

No.	Name	Description
1)	CF card access LED	LED lamp lit when the CF card is accessed
2)	CF card access switch	Switch for disabling the access to the CF card ON: Access to the CF card enabled OFF: Access to the CF card disabled
3)	Eject button	Button for removing the CF card
4)	CF card cover	Cover opening/closing at CF card installation/removal
5)	CF card connector	Connector for installing the CF card
6)	Rating plate	-
7)	CF card unit fixing screw	Mounting screw fixed with a front extension unit or the GOT

4. INSTALLATION PROCEDURE

The following shows how to install the CF card unit on GT15 as an example. For how to install the CF card unit on GT16, refer to GT16 User's Manual.

4.1 CF Card Unit Installation

- Power off the GOT.
- Remove one of the extension unit covers of the GOT and fit the CF card unit along the groove of the GOT case.

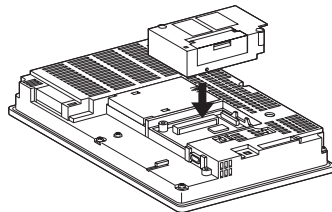
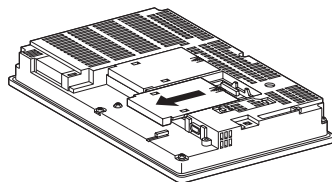

- Fix the CF card unit by tightening its fixing screws (2 places) with a tightening torque of 0.36 to 0.48N·m.

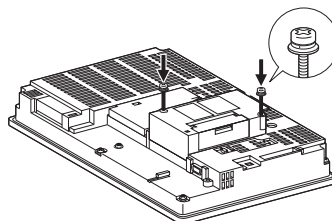

4.2 Installation and Removal Precautions

- Any extension units cannot be installed on the CF card unit. When installing other extension units, install the CF card unit at the last.
- When installing the CF card unit on extension interface 1 (left side), do not install more units on extension interface 2 (right side) than on extension interface 1 (left side). If doing so, the CF card cannot be installed or removed.
- When removing the CF card unit, detach it from the specified direction (PULL) so as not to break the connector.

5. CF CARD INSTALLATION/REMOVAL PROCEDURE

5.1 Installation

- Open the CF card cover and turn off the CF card access switch of the unit.

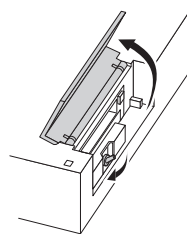

- Insert the CF card into the CF card connector with the face out.

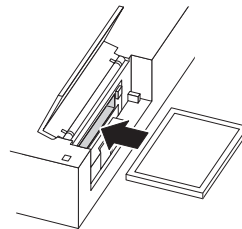

- Turn on the CF card access switch.

5.2 Removal

- Open the CF card cover. Turn off the CF card access switch and check that the CF card access LED turns off. (When the CF card access LED turns off, the CF card can be removed even while the GOT power is on.)

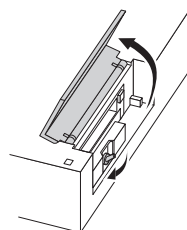

- Press the CF card eject button to pop out the CF card and remove it.

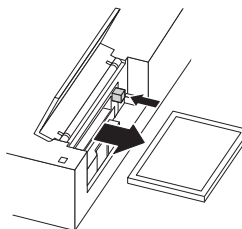

1. OVERVIEW

This User's Manual describes the GT15 CF card unit (hereinafter abbreviated as CF card unit). For the GOTs to which the units can be installed and usable CF cards, refer to GT16 User's Manual or GT15 User's Manual. When using an additional drive, the CF card unit can be used as the B drive of the GOT. The extension units used as the B drive of the GOT are a CF card unit and a CF card extension unit. The CF card unit and the CF card extension unit cannot be used at once.

To use the CF card unit, make the Communication Settings. For setting details, refer to GT16 User's Manual or GT15 User's Manual.

2. SPECIFICATIONS

The performance specifications of the CF card unit are shown below.

Item	Specifications
Internal current consumption (5VDC)	0.07A
Protective structure	IP2X
Weight	0.15kg (0.33lb)

For the general specifications of the CF card unit, refer to GT16 User's Manual or GT15 User's Manual.

MITSUBISHI ELECTRIC CORPORATION
HEAD OFFICE: TOKYO BUILDING, 2-7-3 MARUNOUCHI, CHIYODA-KU, TOKYO 100-8310, JAPAN
NAGOYA WORKS: 1-14, YADA-MINAMI 5-CHOME, HIGASHI-KU, NAGOYA, JAPAN

When exported from Japan, this manual does not require application to the Ministry of Economy, Trade and Industry for service transaction permission.

Specifications subject to change without notice. Printed in Japan.