

FR-A7NL Instruction Manual Supplement

Plug-in option (E kit/E kit cover) dedicated for the FR-E700 series

1 PRE-OPERATION INSTRUCTIONS

1.1 Unpacking and Product Confirmation

Take the plug-in option out of the package, check the product name, and confirm that the product is as you ordered and intact.

This product is a plug-in option unit dedicated for the FR-E700 series.

CAUTION

- **Install a provided front cover for plug-in option, in place of the inverter front cover.**
-

REMARKS

- Echelon[®], LONWORKS[®], LonMaker[®], LONMARK[®] and Neuron[®] are registered trademarks of Echelon Corporation in the U.S.A. and other countries.
Company and product names herein are the trademarks and registered trademarks of their respective owners.

1.1.1 SERIAL number

Check the SERIAL number indicated on the inverter rating plate or package.
For the 200V class of FR-E700, this option can be used with the inverter having the following SERIAL number or later. (For the 400V class of FR-E700, this option can be used with all inverters regardless of SERIAL number.)

Type	SERIAL number
FR-E720-0.1K to 0.75K	J7Y○○○○○○
FR-E720-1.5K to 5.5K	K7Y○○○○○○
FR-E720-7.5K	L7Y○○○○○○
FR-E720-11K, 15K	G7Y○○○○○○

● SERIAL number check

Refer to the inverter manual for the location of the rating plate.



Rating plate example

<u>□</u>	<u>7</u>	<u>Y</u>	<u>○○○○○○</u>
Symbol	Year	Month	Control number
<hr/>			
SERIAL number			

The SERIAL consists of 1 version symbol, 2 numeric characters or 1 numeric character and 1 alphabet letter indicating year and month, and 6 numeric characters indicating control number.
Month is indicated as 1 to 9, X (October), Y (November), and Z (December).

1.1.2 Packing confirmation

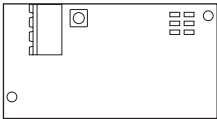
Check the enclosed items.

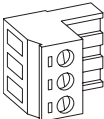
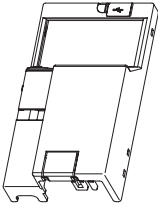
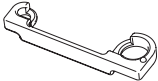
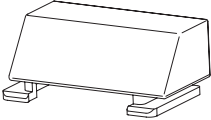
Plug-in option 1 *1 	Mounting screw (M3 × 6mm) 2 *1 	Terminal block 1 *1 
Front cover for plug-in option 1 	Option protective cover 1 *2 	Option small cover (Not used) 1 
Neuron [®] ID bar code sticker..... 1 (Since one bar code sticker is for maker duplicate, three stickers are provided.)		

*1 Not included in the plug-in option E kit cover for the FR-E700 series.

*2 Used with the FR-E720-3.7K (FR-E720-175) or less and FR-E740-7.5K (FR-E740-170) or less.

2 INSTALLATION AND WIRING

2.1 Installation Procedure

The FR-E700 series has one connection connector for the plug-in option.

CAUTION

- Always perform wiring to the main circuit terminals and control circuit terminals before installing the option. Wiring cannot be performed after installing the option. For wiring to terminal RUN, FU, SE of control circuit terminal, run cables to prevent them from being caught between the option board and control circuit terminal block as shown in the right figure. In case cables are caught, the inverter may be damaged.
- When the inverter cannot recognize that the option is mounted due to improper installation, etc., "E. !" (option alarm) is displayed.
- Take care not to drop a mounting screws during mounting and removal.
- Pull out the option straight to remove. Otherwise, the connector may be damaged.

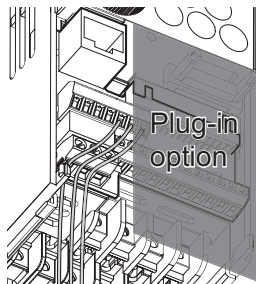

REMARKS

- Because the voltage class, model name and serial (only voltage class is labeled for FR-E740-5.5K (FR-E740-120) or more) are stated on the PU cover, replace a PU cover of a plug-in option front cover with the removed PU cover from the inverter.

● For FR-E720-3.7K (FR-E720-175) or less and FR-E740-7.5K (FR-E740-170) or less

- (1) Remove the front cover from the inverter. (For removing the front cover, refer to the FR-E700 instruction manual.)
- (2) Remove the PU cover from the front cover. Open the PU cover with a driver, etc. and remove it in the direction of arrow as shown below.

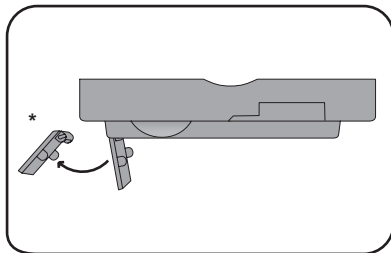

* Open the PU cover, then open it toward the arrow direction to remove.

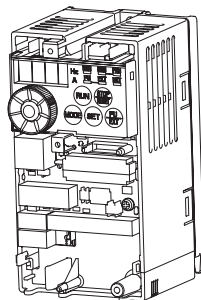
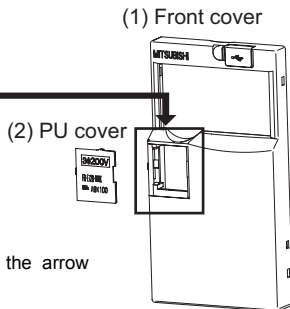

- (3) Install the option protective cover.
- (4) Securely fit the connector of the plug-in option to the inverter connector along the guides.
- (5) Securely fix the both top and bottom of the plug-in option to the inverter with the accessory mounting screws. If the screw holes do not line-up, the connector may not have been plugged snugly. Check for loose plugging.
- (6) Remove the PU cover provided on the front cover for plug-in option and install the other PU cover, which was removed in (2).
- (7) Mount the already wired terminal block to the plug-in option.
- (8) Install the front cover for plug-in option to the inverter.

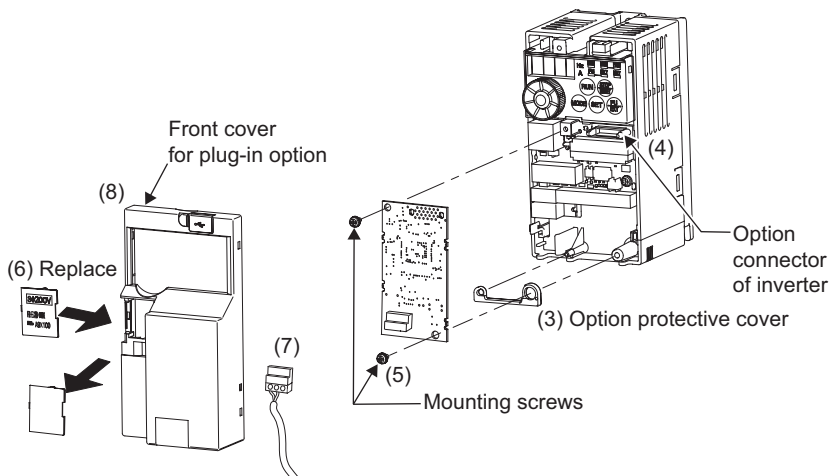

REMARKS

- When the option protective cover is not installed, the protective structure (JEM1030) changes to open type (IP00).

- For FR-E720-5.5K (FR-E720-240) or more and FR-E740-11K (FR-E740-230) or more
 - (1) Remove the front cover 1 and 2 from the inverter. (For removing the front cover, refer to the FR-E700 instruction manual.)
 - (2) Remove the PU cover from the front cover 2. For removing the PU cover, refer to *page 5*.

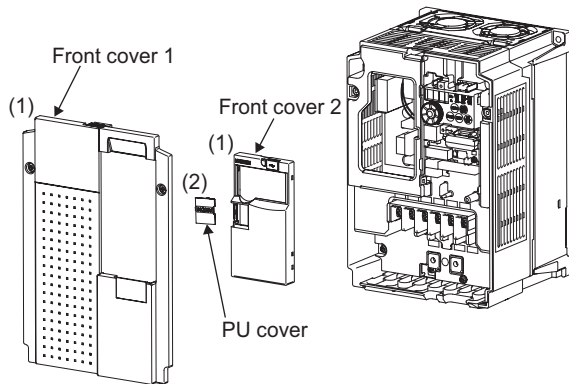

- (3) Install the front cover 1 to the inverter.
- (4) Securely fit the connector of the plug-in option to the inverter connector along the guides.
- (5) Securely fix the both top and bottom of the plug-in option to the inverter with the accessory mounting screws. If the screw holes do not line-up, the connector may not have been plugged snugly. Check for loose plugging.
- (6) Remove the PU cover provided on the front cover for plug-in option and install the other PU cover, which was removed in (2).
- (7) Mount the already wired terminal block to the plug-in option.
- (8) Install the front cover for plug-in option to the inverter.

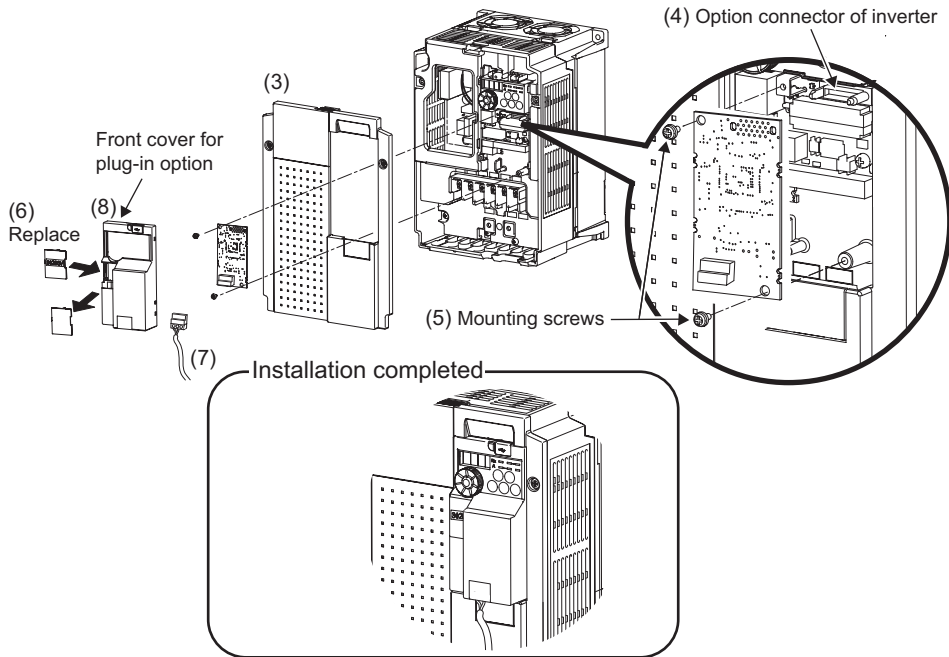

2.2 Wiring

CAUTION

- Always perform wiring to the main circuit terminals and control circuit terminals before installing the option. Wiring cannot be performed after installing the option.

POINT

If a hook of the front cover for plug-in option impedes wiring, cut the hook off and perform wiring.

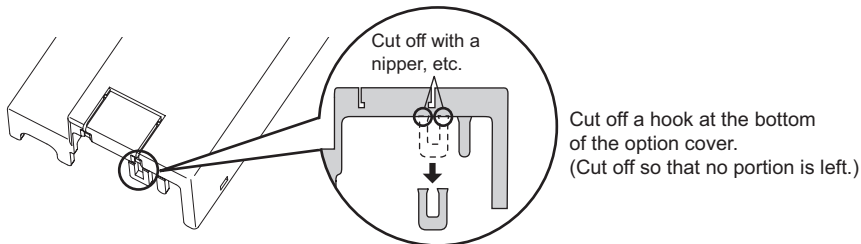

REMARKS

- When the option protective cover is not fitted or wire is not passed through even if the hook of the front cover of the plug-in option has been cut off, the protective structure (JEM1030) changes to open type (IP00).

3 LONWORKS communication function

When using the FR-A7NL with the FR-E700 series, specifications of parameter, I/O signal, alarm, monitor etc. are different from those stated in the FR-A7NL manual. Refer to the FR-E700 series manual for these specifications.