

型 E3X-NM

通用示教型光纤放大器

使用说明书

感谢您选择欧姆龙产品。以下主要记载在安装和使用本产品过程中需注意事项。使用本产品前，请仔细阅读本说明书，充分了解产品。为了您的方便，请妥善保管好本说明书。

1106507-9C

© OMRON Corporation 1998-2010 All Rights Reserved.

规格 / 性能 放大器单元

项目	型号	型 E3X-NM11 (NPN输出)	型 E3X-NM41 (PNP输出)
光源		红色LED (680nm)	
电源电压		DC12~24V ±10%、波动 (p-p) 10%以下	
消费电流		150mA 以下	
响应时间		500μs以下 (在额定检测距离方面)	
控制输出		负荷电流100mA以下 (DC30V以下) 4路集电极开路输出、残留电压1V以下	
计时功能		OFF 延迟 固定40ms * 1	
远程示教输入		ON时: 0V 短接电流 1mA以下 OFF时: 开放或24V以上 (最大输入电压24V) 应答时间: 0.5ms 以下	ON时: 9V以上 (最大输入电压24V) 短接电流 1mA以下 OFF时: 开放或 0V (最大输入电压24V) 应答时间: 0.5ms 以下
指示灯		动作指示灯 (橙色LED), 安定指示灯 (绿色LED)	
示教确认功能		示教指示灯 (红色 / 绿色LED), 蜂鸣器	
保护回路		电源逆接保护、输出短路保护	
使用周围温度		动作时: -25~55℃ (不能有结冰, 结露现象)	
外壳材料		外壳: 聚对苯二甲酸丁二醇酯 (PBT) 保护罩: 聚酯 (PC)	

*1. 计时器的设定、解除请参照【计时器设定】项目内容。

输出段回路图

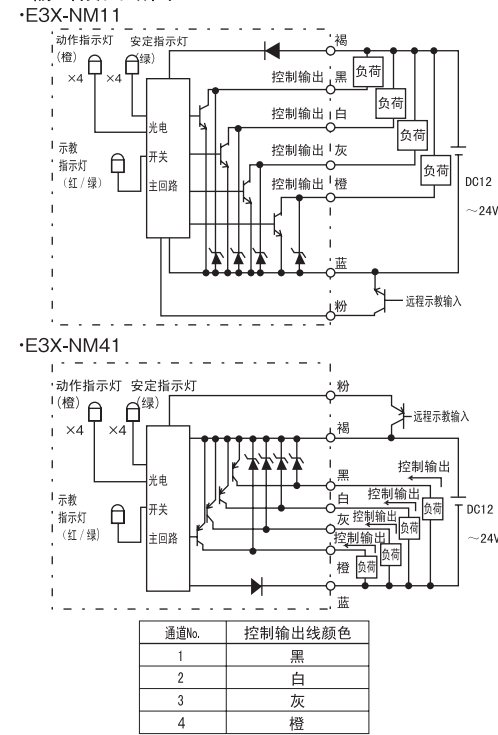

通道No.	控制输出线颜色
1	黑
2	白
3	灰
4	橙

外形尺寸图

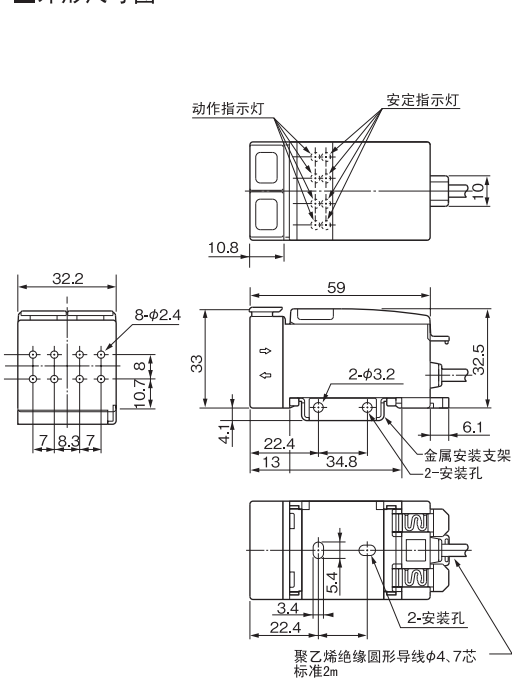

安全上的要点

- 以下项目在安全确保方面非常重要，请务必遵守。
- 请不要在具有可燃性、爆炸性气体的环境下使用。
 - 请勿拆卸、修理、改造本产品。
 - 电源电压必须在额定值内。
 - 请使用额定值以下的负荷。

正确使用方法

(1) 放大器单元的安装

● 光纤头部分的安装

光纤单元	固定转矩强度
M3螺丝型 M4螺丝型	0.78N·m以下
M6螺丝型 φ6圆柱型 φ6特氟龙型	0.98N·m以下
φ2圆柱型 φ3圆柱型 φ5特氟龙型	0.29N·m以下

● 光纤单元的弯曲

在弯曲光纤单元时，请保持弯曲半径在 25mm 以上。如果弯曲半径小于 25mm 的话，检出距离将会缩短。(在弯曲 E32-D51/T51 光纤单元时，保持弯曲半径在 35mm 以上) 弯曲半径在 4mm 以上的可以使用 E32-T11、T21、D11 和 D21 型的光纤单元。

在光纤单元末端附近，请留出 20mm 以上的直线距离。(E32-T11、T21、D11和D21型光纤单元除外。)

● 不锈钢管的弯曲

在弯曲不锈钢管时，保持弯曲半径在 10mm 以上。如果弯曲半径小于 10mm 的话，检出距离将会缩短。

● 光纤单元的铺设

- 请不要使光纤始终处于超过 29N 的压力之下。(光纤单元使用型号 E39-F9 的附属品，光纤除自由切割型外最大力不能超过 9.8N。)
- 请不要加压，加重。

(2) 光纤的切断

光纤可以在使用型号 E39-F4 的工具下被切断。可以切割成所希望的长度。

- 将光纤的光学导线插入光纤切割器的孔中。将所切割的导线推过切割器的孔直到希望的长度。
- 在其中一个孔中将刀片推下切断光纤导线。

如果要切割其它光纤导线，请使用 1 个不同的孔了保证刀片的锋利。另外，如果使用迟钝的刀片切割光纤导线，检出距离将会缩短因为光纤粗糙的表面。

(3) 光纤插入标记的加工

将光纤光学线插入光纤切割器末端的孔中。(参照以下的外形图)为了能在光纤光学线上记下清晰且适当的插入记号，将光纤光学线安全地插入孔的底部，然后安心地推下切割器。

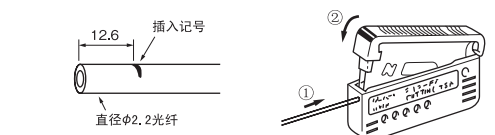

(4) 放大器单元和光纤单元的连接

光纤单元和放大器单元连接的好坏对产品特性的好坏影响很大，请正确连接光纤单元和放大器单元。

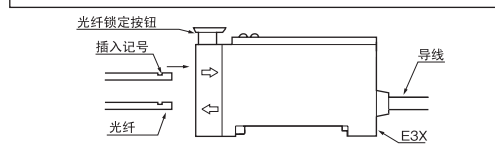

E3X-NM 的光纤和放大器单元使用的是一次性操作设定的方式。插入和拔出光纤请按照如下描述操作。

1) 光纤的锁定和释放

请在 -10 ~ +40℃ 范围内执行。

2) 光纤的标记

在使用光纤切割器 (E39-F4) 切割光纤之后，将光纤插入指示记号。在每一根光纤的顶端 (除自由切割型外) 都有一个表示确认插入位置的标记。如果光纤正好插入这个位置时可以用到它。

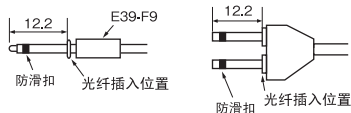

3) 光纤的插入

插入光纤时听到咔嚓声，然后按下锁定按钮。通过进行这样的操作可以固定光纤。

4) 光纤的拔出

再次按下锁定按钮。当锁释放时，光纤可以被拔出。请不要用力地拔起锁定按钮。(为了不损坏光纤，在拔出光纤前请确认锁定按钮是否已经被释放。)

5) 放大器单元安装支架的安装

(使用 DIN 导轨)

- 安装
- 将放大器前部的开槽处插入 DIN 导轨，使之接合。
 - 将后部开槽处插入 DIN 导轨。
- (注) 请先接合前部开槽处 (图中①)，否则会引起机械强度的衰退。

拆卸

向前推出导轨 (图中③) 然后向上提起前部开槽处 (图中④)。

使用专用安装支架侧面的安装

- 在放大器上固定专用安装支架。
- 使用 M3 螺丝安装。
- 使用直径最大 6mm 的平垫圈。

(6) 其他的注意点

- 光学光纤是由甲基丙烯酸 (酯) 树脂组成的。请不要在有机溶剂和其它有害物质环境下使用。
- 请不要将受光表面直接暴露在外光线下等。同时也不要不要在室外使用。
- 虽然产品的防水等级为 IP67，在有水滴和灰尘的条件下检出距离会缩短。
- 光电开关导线和动力线或电力线装在同一配管中使用时，会受到干扰，有误动作甚至被损坏。原则上传感器导线必须单独放置或者被屏蔽。
- 延长导线必须使用截面积 0.3mm² 以上、长度 100m 以下导线。
- 电源

当使用市场上销售的开关整流器时，请将 FG (Frame Ground) 端子接地和 G 端子接地。否则，会由于电源的开关噪声引起故障。

7) 电源开启后的操作

从接通电源到传感器可正常进行检出的时间是 100ms。所以请在通电 100ms 后再使用。负载和传感器接不同电源时，一定要先接通传感器的电源。

8) 输出短路保护功能

当短路保护功能工作时，4 通道所有的输出将会关闭。

9) E² PROM 书写错误

示教时 (包括直到无工件示教的初期动作水平修正结束为止) 由于切断电源及静电等产品的干扰而产生记入错误的情况下 (蜂鸣器、示教指示灯、红/绿灯同时闪烁，动作指示灯、稳定指示灯闪烁)，请以主机的按钮重新进行示教。

*记忆错误的情况与示教错误不同，示教指示灯红/绿灯同时闪烁，稳定指示等也出现闪烁。

10) 出荷时放大器单元已经设置为最大灵敏度状态，因此它们能在最大灵敏度状态下直接使用而不需要更改设定。

操作顺序

- 安装放大器单元。(参照“正确使用方法”)
- 将光纤插入放大器单元，在检出距离内设定光纤。(参照“正确使用方法”)
- 打开电源。
- 灵敏度调整请按照灵敏度调整顺序进行设定。(参照“灵敏度调整”)
- 当需要使用 OFF 延迟计时器功能时，请按计时器设定顺序进行设定。(参照“计时器设定”)
- 确认模式设定切换开关设定在 [RUN] 侧。
- 设定动作模式请用动作模式选择开关。

灵敏度调整

● 各部分的名称

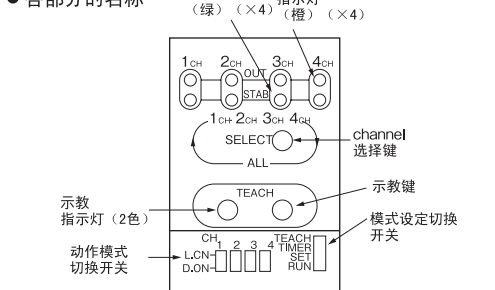

● 最大灵敏度设定

- 在检测距离内设定光纤。
- 将模式设定切换开关设定在 [TEACH] 侧。
- 在使用型号 E3X-NM 时，按 channel 选择键，选定所希望的频道。这时，被选中的 channel 的稳定指示灯会闪光。频道选择顺序如下所示。
1CH → 2CH → 3CH → 4CH → ALL
(ALL 的时候，为所有的频道汇总设定)
- 超级闪烁功能启动，对合光轴使投光器光纤前段指示灯亮。(光轴偏移时指示灯闪烁，且有蜂鸣声)
- 按动示教按钮 (3 秒以上)。(这时有无工件并不要紧)
示教指示灯…红 → 绿
蜂鸣器 (内置)…亮红灯 1 次，亮绿灯时连续发声，不按示教按钮时蜂鸣声停止。
如果要继续设定其他通道的话，请返回第 3 步。
- 将模式设定切换开关设定在 [RUN] 侧。
最大灵敏度设定结束。
示教指示灯…熄灯
(注) 设定最大灵敏度时，与光纤的设定距离及入光/遮光无关，是自动进行灵敏度设定的。
- 请用动作模式切换开关 (L.ON/D.ON) 设定所希望的逻辑输出。

● 无工件示教

- 把光纤设定在检测距离。
- 把模式设定切换开关拨到 [TEACH] 侧。
- 型号 E3-NM 的情况下，用 channel 选择键选择了所需频道后，按示教键，此时，被选中的 channel 的稳定指示灯会闪光。
- 超级闪烁功能启动，对合光轴使投光器光纤前段指示灯亮。(光轴偏移时指示灯闪烁，且有蜂鸣声)
- 无工件状态下按示教键。(0.5 ~ 2.5 秒)
(这时有无工件并不要紧)
示教指示灯…红色灯亮
蜂鸣器 (内置)…蜂鸣音 (1 次)
如果要继续设定其他通道的话，请返回第 3 步。
- 把模式切换开关拨到 [RUN] 侧。
第一个工件通过后，无工件示教设定完成。
示教指示灯…红色灯亮 → 绿色灯亮 (1 秒后自动熄灭)
- 用动作模式切换开关 (L.ON/D.ON) 设定所需的逻辑输出。

(注1) 考虑到工件前后摇晃及颜色偏差，对前 5 个工件的光量进行抽样。用光量最低的工件和背景的中间值重新设定动作程度。

(注2) 无工件示教设定到 RUN 模式后，最初 (第一个) 工件出来，动作程度确定后 1CH 约要 60ms。在用型号 E3X-NM (4CH 型) 时，各个 CH 中工件流出时，每个 CH 中流出工件的间隔要在 60ms 以上，另外，动作程度决定以后，以 500 μs 的应答速度工作。

● 工件有/无示教

- 把光纤设定在检测距离内。
- 把模式设定切换开关拨到 [TEACH] 侧。
- 型号 E3-NM 的情况下，用 channel 选择键选择了所需频道后，按示教键，此时，被选中的 channel 的稳定指示灯会闪光。
- 超级闪烁功能启动，对合光轴使投光器光纤前段指示灯亮。(光轴偏移时指示灯闪烁，且有蜂鸣声)
- 把工件放到所设定位置，按示教键 (一次)。

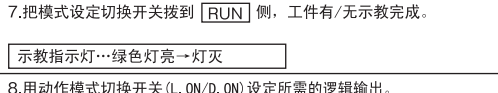
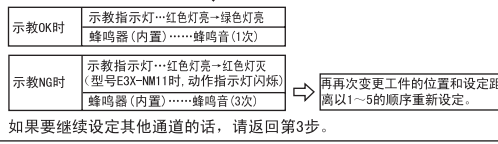
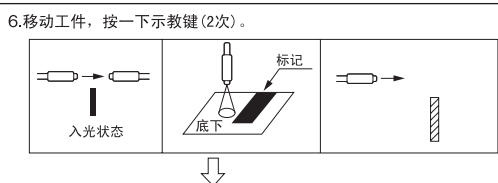
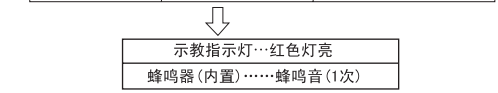
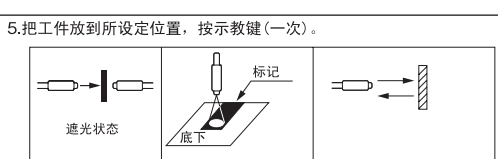

● 计时器设定

- 请您在 [TIMERSET] 侧设置，模式设定切换开关。
- 用 channel 选择按钮来选择 channel。这时被选 channel 的稳定指示灯会闪烁。频道选择顺序如下所示。
1CH → 2CH → 3CH → 4CH → ALL
(ALL 时，为所有的频道汇总设定。)
- 按动示教按钮可进行计时器设定。这时动作指示灯亮 (如果再次按一次示教按钮可解除计时器设定，动作指示灯随之熄灭)。
- 请把模式设定切换开关设置到 [RUN] 侧。

● 远程示教功能

与基本的「灵敏度设定」相同，无需按动示教按钮，根据远程示教设定输入信号即可进行示教。

- 请把模式设定切换开关设置到 [RUN] 侧。
- 在远程示教输入时，请满足下图所示的信号条件。

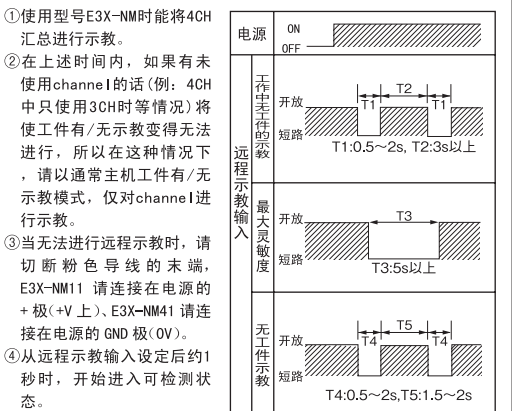
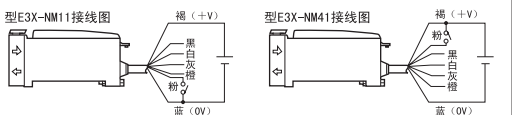

● 对合光轴 (超级闪烁功能)

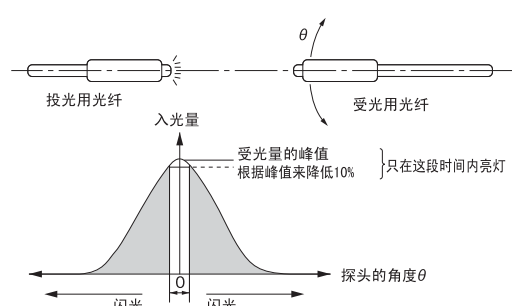

如果对模式切换开关设定为 [TEACH] 模式的话，即可启动超级闪烁功能。在对合光轴时，光纤探头的光轴偏移的情况下，如果受光量的峰值减少 10% 以上的话，闪烁功能就会启动工作。(投光闪亮，同时蜂鸣器发出蜂鸣) 因为根据光纤探头进行光轴对合，可记录下受光量的峰值，所以请在投光用光纤前端亮灯时使用。

安全上的注意

警告表示的意思

注意 如果不正确使用的话，有可能引起轻伤、中等程度的伤害还有可能带来同样重大的物质损害。

警告表示

注意 不可将传感器连接交流电源，有爆裂的危险。

使用时的承诺事项

使用于下列用途时，与本公司营业担当者商谈之后，根据规格书等确认的同时，对额定性能方面请想出有充裕度的使用方法及采取即使万一出现故障也能使危险降低到最小的安全回路等的安全对策。

- 屋外的用途、潜在化学污染或者受到电气的妨害的用途或者在商品目录、使用说明书中没有记载的条件及环境下使用。
 - 原子力控制设备、焚烧设备、铁道、航空、车辆设备、医用机械、娱乐机械、安全装置及行政机关及根据个别业界的规定的制造的设备。
 - 可能危及生命、财产的系统·机械·装置。
 - 煤气、水道、电气的供给系统及 24 小时连续运转系统等需要高信赖性的设备。
 - 其他，以上的 (1)~(4) 为基准，需要高度安全性的用途。
- *上述内容是适用条件的一部分。仔细阅读本公司的综合商品目录、数据表等最新版商品目录、手册中记载的保证负责事项的内容后再使用。

联络处所在地

技术支持

欧姆龙 (中国) 有限公司
地址: 中国上海浦东新区银城中路 200 号
中银大厦 2211 室
电话: 86-21-5037-2222
技术咨询热线: 800-820-4535
网址: www.fa.omron.com.cn

制造

欧姆龙 (上海) 有限公司
地址: 中国上海浦东新区金桥出口加工区金吉路 789 号
电话: 86-21-5050-9988
邮编: 201206

OMRON

Model E3X-NM

OPTICAL FIBER PHOTOELECTRIC SENSOR

INSTRUCTION SHEET

Thank you for selecting OMRON product. This sheet primarily describes precautions required in installing and operating the product. Before operating the product, read the sheet thoroughly to acquire sufficient knowledge of the product. For your convenience, keep the sheet at your disposal.

TRACEABILITY INFORMATION:

Representative in EU: Manufacturer:
 Omron Europe B.V. Omron Corporation,
 Wegalaan 67-69, Shiockoji Horikawa, Shimogoyu-ku,
 2132 JD Hoofddorp, Kyoto 600-8530 JAPAN
 The Netherlands Shanghai Factory
 No.789 Jinji Road,
 Jinjiao Export Processing District,
 Pudong New Area, Shanghai, 201206 CHINA

The following notice applies only to products that carry the CE mark:
 Notice:
 This is a class A product. In residential areas it may cause radio interference, in which case the user may be required to take adequate measures to reduce interference.

1106507-9C

© OMRON Corporation 1998-2010 All Rights Reserved.

PRECAUTIONS FOR SAFE USE

Be sure to follow safety precautions below for added safety.

- Do not use the sensor under environment with explosive or ignition gas.
- Never disassemble, repair nor tamper with the product.
- Keep the supply voltage within the specified range.
- Do not use the sensor over the rated values.

PRECAUTIONS FOR CORRECT USE

(1) Mounting of fiber unit

● Mounting of a head part

Screw-mounting Model

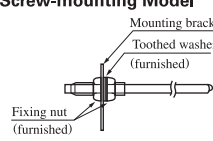

Fiber unit	Clamping torque
M3 screw M4 screw	Max.0.78N·m
M6 screw 6 dia. cylinder 6 dia. teflon	Max.0.98N·m
2 dia. cylinder 3 dia. cylinder 5 dia. teflon	Max.0.29N·m

Column Model

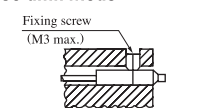

● Bending the fiber unit

When bending the fiber unit, keep a bending radius over 25mm. The sensing distance will be reduced if the radius is smaller than 25mm. (When bending the fiber unit of type E32-D51/T51, keep a bending radius over 35mm)

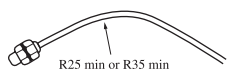

E32-T11, T21, D11 and D21 can be used over 4mm bending radius.

Near the ends of the fiber unit, leave a straight part over 20mm. (Exception: E32-T11, T21, D11 and D21.)

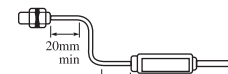

● Bending the stainless steel tube

When bending the stainless steel tube, keep a bending radius over 10mm. The sensing distance reduces if the radius is smaller than 10mm.

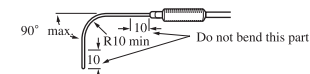

● After connecting the fiber optic cable.

Do not keep the fiber pulled by a force of over 29N. (Fiber units using the attachment type E39-F9 and fiber except for free cut types are 9.8N max.)

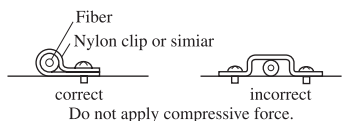

(2) Handling E39-F4 cutting tool

The fiber can be cut with the aid of cutting tool type E39-F4. Cut the fiber to your desired length.

● Cutting the Fiber

To cut 2.2-mm dia. Fiber Optic Cable

Insert a fiber optic cable into a hole of the Fiber Cutter. Push the blade down in one stroke to cut off the cable. To cut another cable, use a different hole than before to assure blade sharpness. Otherwise, the sensing distance may be reduced because of the rough surface of the cut fiber optic cable produced by the dulled cutting tool blade.

(3) Marking Fibers

Insert the fiber optic cable again into the end hole of the Fiber Cutter. (Refer to the following figure.) To inscribe a clear and properly located insertion mark on the fiber optic cable, insert the fiber optic cable securely to the bottom of the hole, and push down the Fiber Cutter securely.

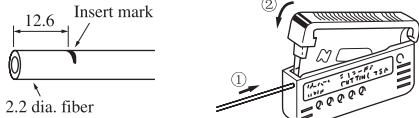

The fiber optic cable must be inserted so that the insertion mark is located at the surface of the amp unit. Otherwise, the sensing distance may be reduced.

(4) Connection of amplifier unit and fiber unit

Insert the fiber unit into the amplifier unit securely. Sensing characteristics are strongly influenced by connection secureness.

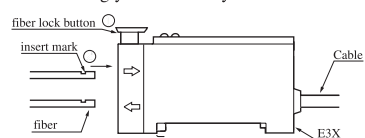

Securing Fibers

The E3X-NM Fiber Amplifier Unit uses a one-touch lock method. Insert and remove fibers as described below.

RATINGS/PERFORMANCE AMPLIFIER UNIT

Item	Model E3X-NM11 (NPN transistor output)	E3X-NM41 (PNP transistor output)
Light source	Red LED(680nm)	Red LED(680nm)
Supply voltage	12 to 24V DC ±10% ripple(p-p) below 10%	12 to 24V DC ±10% ripple(p-p) below 10%
Current consumption	Max. 150mA	Max. 150mA
Response time	Max. 500µs	Max. 500µs
Control output	load current Max. 100mA(Max. 30V DC) open collector 4 output residual voltage below 1V	load current Max. 100mA(Max. 30V DC) open collector 4 output residual voltage below 1V
Timer function	OFF delay timer fixed at 40ms(*1)	OFF delay timer fixed at 40ms(*1)
External teaching function	When turning on: 0V short-circuit current Max. 1mA (Maximum input voltage 24V) When turning off: open or more than 9V (Maximum input voltage 24V) Response time: Max. 0.5ms	When turning on: Min. 9V short-circuit current Max. 1mA (Maximum input voltage 24V) When turning off: open or 0V Response time: Max. 0.5ms
Indicator	Operation indicator(orange LED) Stability indicator(green LED)	Operation indicator(orange LED) Stability indicator(green LED)
Teaching check function	2-color indicator(red/green LED) buzzer	2-color indicator(red/green LED) buzzer
Protective circuit	Reverse connection protection Output short-circuit protection	Reverse connection protection Output short-circuit protection
Ambient operating temperature	-25 to 55°C(no freezing)	-25 to 55°C(no freezing)
Housing material	Housing: Polybutylene terephthalate Cover: Polycarbonate	Housing: Polybutylene terephthalate Cover: Polycarbonate

*1. Refer to "Timer setting" on timer set and reset.

1) Locking and Releasing Fibers

Carry out the operations within a temperature range of -10 to 40°C

2) Marking Fibers

After cutting the fiber with a fiber cutter (E39-F4), insert the fiber up to the indicator mark. The tip of each fiber except for free cut types have a depth indicator to confirm the insert position. Use it if the fiber is precisely inserted to this position.

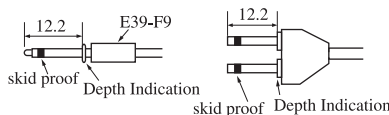

3) Inserting Fibers

Insert the fiber and then secure it by pressing the lock button until it snaps into place.

4) Removing Fibers

Press the lock button again. When the lock is released, the fiber can be pulled out. Do not forcibly pull up on the lock button. (In order not to damage the fiber, check to be sure that the lock is released before pulling the fiber out.)

(5) Mounting of the amplifier unit

Mounting

1) Engage the front slot of the amplifier into the DIN rail.

2) Push the back slot into the DIN rail.

Note: Engage the front slot ① first, otherwise it may cause deterioration of mechanical strength.

Removing

Push forward ③ and raise the front slot ④.

< Side mounting by using the exclusive mounting bracket >

- Fix the exclusive mounting bracket at the amplifier.
- Mount with M3 screw.
- Use a plain washer which size is 6 dia. maximum.

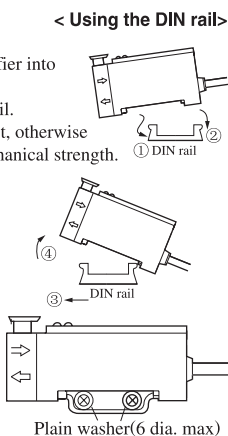

(6) Others

- The optical fibers consist of methacrylate resin. Do not use them near organic solvents and other adverse matters.
- Do not expose the receiving surface direct to external interference light, etc. Do not use the unit outdoors, either.
- Though the degree of protection are constructed as IP67, the detecting distance will decrease with the addition of dropping of water of dust.
- There are some cases where the photoelectric switch cable is unavoidably laid in a tube or duct together with a high-tension or power line. This causes an induction, possibly resulting in malfunction or damage. In principal, the cable should be separately laid or shielded.
- To extend the cable, use a wire of 0.3mm² or more. However do not extend it more than 100m.
- Power source. When employing a commercially available switching regulator, ground the frame ground terminal(FG) and ground terminal(G). Otherwise, malfunction may result from switching noise at the power source.
- Operation after the power is turned on. The E3X-N will begin sensing no later than 100ms after the power is turned on. If the load and the E3X-N operate on different power supply, the E3X-N must always be turned on first. When power is on, operation indicator lightens an instant, however output does not turn on.
- Output Short-circuit Protection. When short-circuit protection is operating, the output from all four channels will turn off.
- E²PROM write errors. If a write error (buzzer, teaching indicator: red/green flashing simultaneously, output and stability indicators: flashing) occurs during teaching (including anytime up to the completion of terminal operation level compensation for Non-work sensitivity setting) due to a power failure or noise from static electricity, execute the teaching again using the button on the main unit. *If a write error occurs, in contrast to a teaching error, the teaching indicator flashes red and green simultaneously and the stability indicator flashes.
- The units are set for the maximum sensitivity at the time of shipping, so they can be used for maximum sensitivity without changing the setting.

OPERATION PROCEDURE

- Mount the amplifier unit. (refer to "NOTICE")
- Insert the fiber unit into the amplifier unit and place the fiber unit within the sensing distance. (refer to "NOTICE")
- Turn on the power supply.
- Adjust the sensitivity. (refer to "SENSITIVITY ADJUSTMENT")
- When using OFF delay timer function, set according to "TIMER SETTING". (refer to "TIMER SETTING")
- Confirm that the mode selector switch is set to "RUN".
- Set operating mode with the operating mode selector switch.

SENSITIVITY ADJUSTMENT

Names of Parts

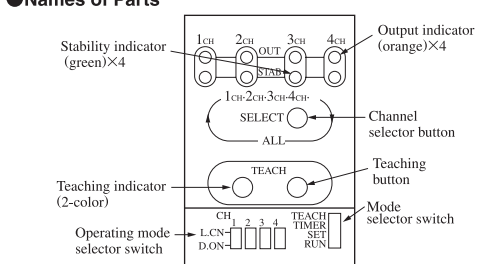

OUTPUT STAGE CIRCUIT DIAGRAM

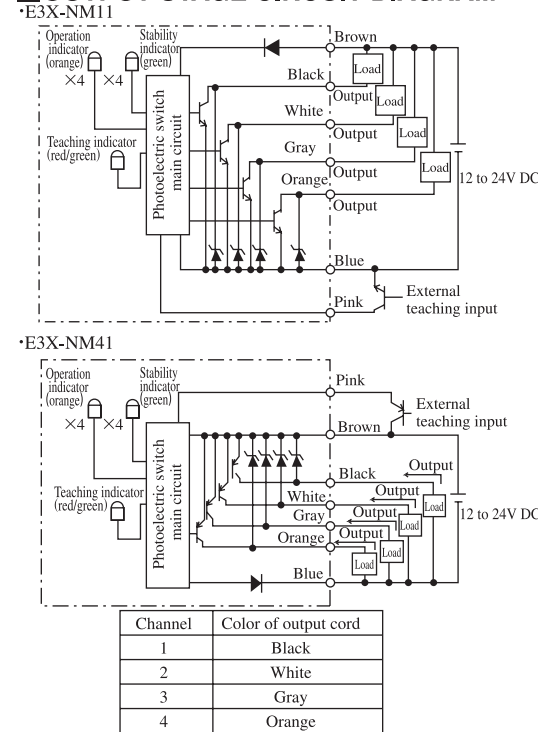

OUTLINE DRAWING

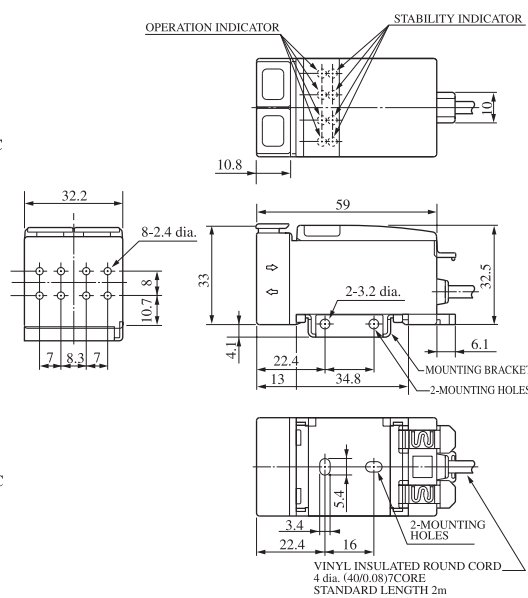

Maximum sensitivity setting

- Place the fiber units within the sensing distance.
- Set the mode selector switch to the **TEACH** position.
- Select channel by channel selector button. At this time, stability indicator of selected channel flashes. Channel order follows as 1CH→2CH→3CH→4CH→ALL. In case of "ALL", all channel is set simultaneously.
- Set the logical output by the selector switch of the operational mode.
- Press the teaching button. (3s. min)
Teaching indicator: Turns from red to green.
Buzzer (built-in): Beeps (once in red, the continuous sounds in green, sound stops when teaching button is released.)

If you want to set another channel continuously, return to No.3.

- Set the mode selector switch to the **RUN** position. Now the maximum sensitivity setting is complete.

Note: The maximum sensitivity setting can be made regardless of the setting distance of the fiber unit and whether the incident light is received or interrupted.

- As the flashing function operates, set the optical axis in the state of the end of the light source fiber lighting. (When the optical axis is out of alignment, it turns on and off.)

Non-work sensitivity setting (Note1, Note2)

- Place the fiber units within the sensing distance.
- Set the mode selector switch to the **TEACH** position.
- Select channel by channel selector button. At this time, stability indicator of selected channel flashes.
- Set the logical output by the selector switch of the operational mode.
- Press the teaching button. (0.5 to 2.5s)
At this time, you do not have to care whether there is a work or not.
Teaching indicator: Lights up in red.
Buzzer (built-in): Beeps (once).

If you want to set another channel continuously, return to No.3.

- Set the mode selector switch to the **RUN** position. Now the Non-work sensitivity setting is complete.

Note1) When Non-work sensitivity setting is used, five works are taken of the amount of work light after the set value, and the appropriate sensitivity is reset.

Note2) After RUN mode has been set when Non-work sensitivity setting is used, approximately 60 ms is required per channel until the first work is moved and the operation level is determined. To move the work for each channel, allow an interval of at least 60 ms per channel. Once the operation level has been determined, operation will be conducted at the normal response speed (500µs).

Sensitivity setting

- Place the fiber units within the sensing distance.
- Set the mode selector switch to the **TEACH** position.
- Select channel by channel selector button. At this time, stability indicator of selected channel flashes.
- Set the logical output by the selector switch of the operational mode.
- Place a work sample at a specified position and press the teaching button (first time).

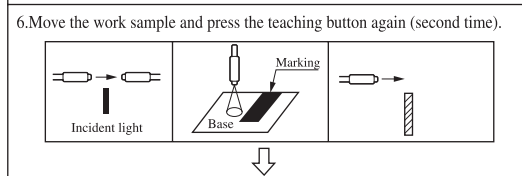
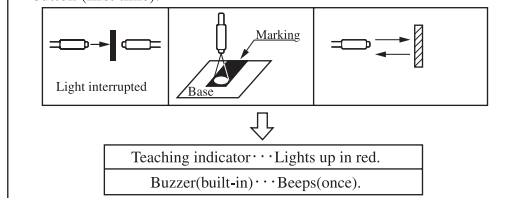

- Set the mode selector switch to the **RUN** position. Now the sensitivity setting is complete.

Teaching indicator: After lights up in green, turns off.

- As the flashing function operates, set the optical axis in the state of the end of the light source fiber lighting. (When the optical axis is out of alignment, it turns on and off.)

Timer setting

- Set the mode selector switch to the **TIMER SET** position.
- Select channel by channel selector button. At this time, stability indicator of selected channel flashes. Channel order follows as 1CH→2CH→3CH→4CH→ALL. In case of "ALL", all channel is set simultaneously.
- Timer is set by pushing teaching button. At this time, output indicator of the channel lights up. (If you push teaching button once again, timer is reset and output indicator goes out.)
- Set the mode selector switch to the **RUN** position. Now the timer setting is complete.

External teaching function

This function is basically the same as the sensitivity adjustment. Instead of pressing the teaching button, however, the external teaching setting input signal is used for teaching.

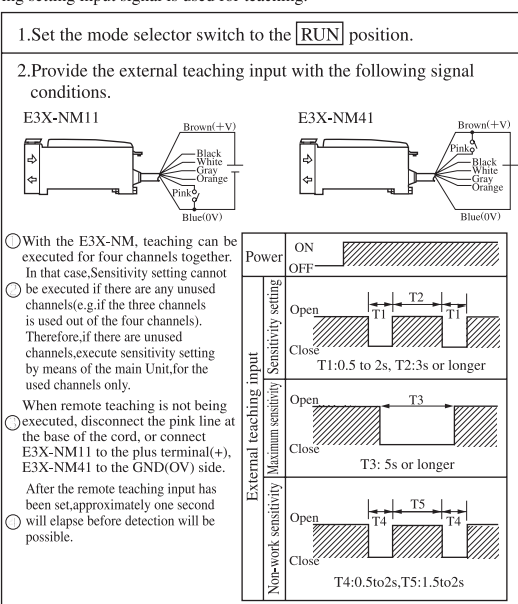

Optical axis adjustment (Super-flashing function)

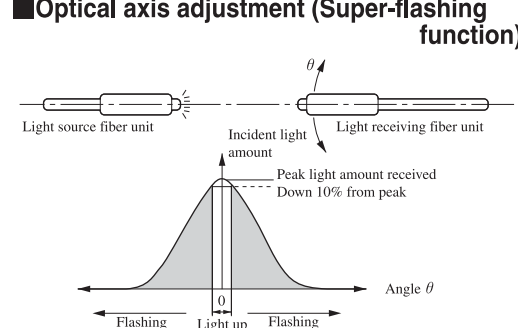

Set the mode switch to **TEACH**. If the optical axis of the fiber head is out of alignment, the super-flashing function will operate when the amount of light received is down by 10% or more from the peak value. (A buzzer will sound simultaneously with the flashing.) If the optical axis is out of alignment, the peak value of the light received will be saved in memory by matching the fiber head with the optical axis, so carry out the operation when the end of the light source fiber is lit. The super-flashing function will not operate if the teaching button is pressed before or during aligning of the optical axis.

PRECAUTIONS FOR SAFETY NOTE

- Meaning of Signal Words**
 - CAUTION** Indicates a potentially hazardous situation which, if not avoided, may result in minor or moderate injury or in property damage.
- Alert statements**
 - CAUTION** Do not connect sensor to AC power supply. Risk of explosion.

Suitability for Use

THE PRODUCTS CONTAINED IN THIS SHEET ARE NOT SAFETY RATED. THEY ARE NOT DESIGNED OR RATED FOR ENSURING SAFETY OF PERSONS, AND SHOULD NOT BE RELIED UPON AS A SAFETY COMPONENT OR PROTECTIVE DEVICE FOR SUCH PURPOSES. Please refer to separate catalogs for OMRON's safety rated products.

OMRON shall not be responsible for conformity with any standards, codes, or regulations that apply to the combination of the products in the customer's application or use of the product.

Take all necessary steps to determine the suitability of the product for the systems, machines, and equipment with which it will be used. Know and observe all prohibitions of use applicable to this product.

NEVER USE THE PRODUCTS FOR AN APPLICATION INVOLVING SERIOUS RISK TO LIFE OR PROPERTY ENSURING THAT THE SYSTEM AS A WHOLE HAS BEEN DESIGNED TO ADDRESS THE RISKS, AND THAT THE OMRON PRODUCT IS PROPERLY RATED AND INSTALLED FOR THE INTENDED USE WITHIN THE OVERALL EQUIPMENT OR SYSTEM. See also Product catalog for Warranty and Limitation of Liability.

Technique Support
 OMRON (China) Co., Ltd
 Address: RM2211, Bank of China Tower,
 Pudong New Area,
 Shanghai China
 Phone : 86-21-5037-2222
 Free call: 800-820-4535
 Industrial Web: www.fa.omron.com.cn
 Manufacture
 OMRON (Shanghai) Co., Ltd
 Address: Jin Ji Rd. 789, Jin Qiao
 Export Processing Area,
 Pudong New Area,
 Shanghai China 201206
 Phone: 86-21-5050-9988

OMRON Corporation